

Instruction Manual for the Volkswagen Transporter.



The fuel consumption depends to a large extent on the style of driving

To use as little fuel as possible, always drive smoothly and steadily.

Avoid

- **Full throttle acceleration**

and

- **Maximum speeds**

Please read the "Driving tips" section.

You will then use less fuel.

Road safety and vehicle safety belong together

Before moving off, check

- the fuel level
- the lights and turn signals
- the brakes
- the windscreen washer and, at regular intervals
- the engine oil level
- the brake fluid level
- the tyre pressure

You will then have less to worry about.

Instruction Manual for the Volkswagen Transporter.

January 1980 Edition

Volkswagenwerk Aktiengesellschaft · Wolfsburg

Looking "through" the Transporter

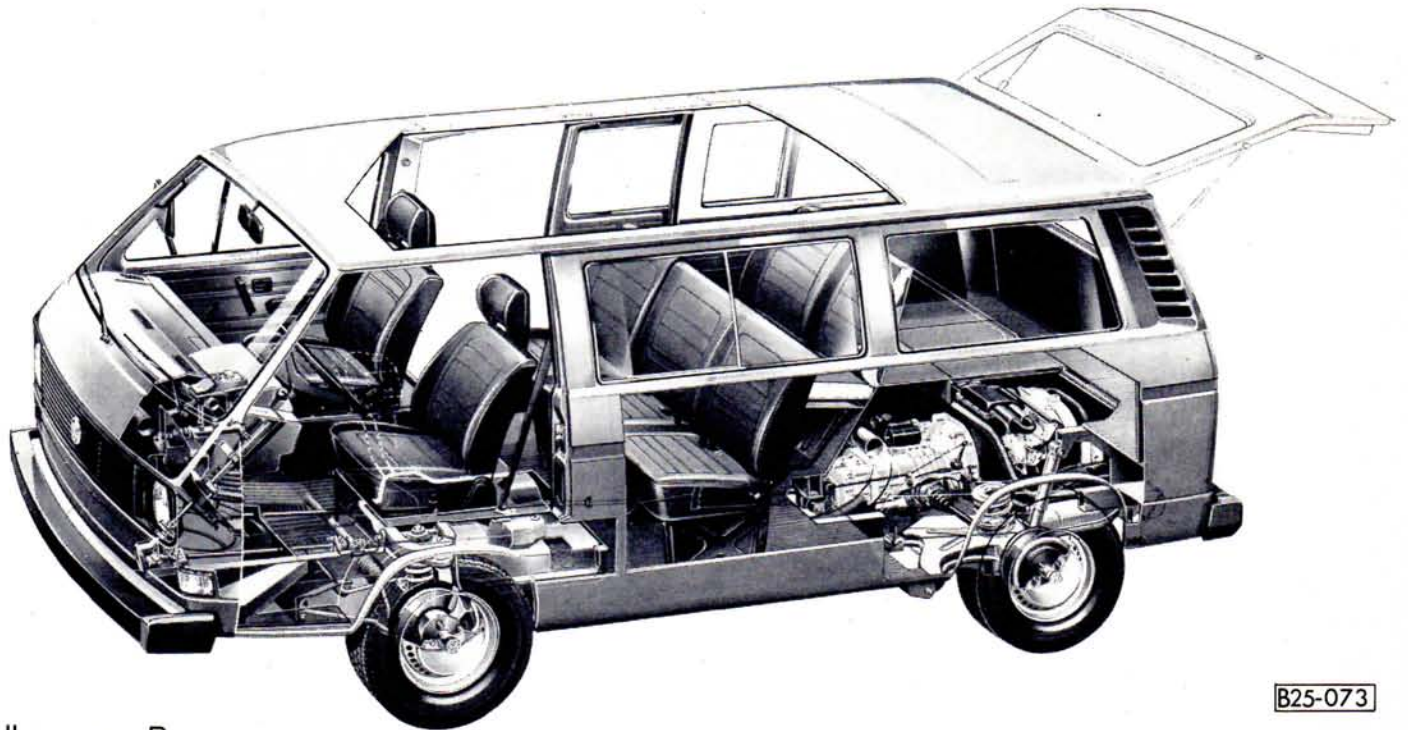

B25-073

2 Volkswagen Bus

Among the publications supplied with your new vehicle are the:

Instruction Manual and the
Service Schedule

Both are to be found in the vehicle wallet.

The Instruction Manual contains important information on the use and treatment of your vehicle. You should read this booklet before using the vehicle so that you get to know your car quickly and can start the first trip with complete confidence. After reading the booklet you will know exactly how to drive and look after your vehicle properly.

Please note that some of the items of equipment described are fitted to certain models only or are optional extras.

The **Service Schedule** contains details of what has to be done at regular intervals to maintain the roadworthiness and value of the vehicle. When the servicing has been carried out, your V.A.G dealer confirms this by stamping the schedule.

You should always have the Service Schedule handy when you take your car to a dealer – it is the key to efficient service.

A word about the warranty conditions: Proper treatment and complete proof that all the specified Standard Services have been carried out by a V.A.G dealer are stipulations for the upholding of any warranty claims for damage to parts which are covered by the Standard Service system.

It is therefore in your interests to take your car in regularly for a Standard Service.

Volkswagenwerk Aktiengesellschaft

Contents

	Page		Page		Page
Instrument panel	6	Warning lamps for Engine oil pressure	22	Sun visors	35
		Generator	22	Ashtrays, glove box	35
Operation		Brake system	23	Socket/cigarette lighter	35
Keys	8	Speedometer	24	Interior light, interior mirror	36
Doors		Trip recorder	24	Loading limit	36
Cab doors	8	Fuel gauge	25	Cover (Pick-up)	36
Sliding door	9	Clock	25		
Windows (vent wings, sliding windows)	10	Lighting switch	26		
Rear flap	11	Emergency light switch	27	Driving tips	
Seats		Fog/rear fog lights/Heated rear window	27	The first 600 miles (1000 km) and afterwards	37
Cab seats	12	Turn signal and dip switch	28	Driving safely	
Passenger compartment seats	13	Headlight flasher	28	Tyres	38
Head restraints	14	Parking lights	28	Brakes	38
Seat belts	15	Windscreen wipers	29	Driving economically	39
Luggage compartment	18	Windscreen washer	29	Winter driving	
Gear lever	19	Headlight washer	29	Air cleaner/intake air preheating, fuel	40
Reversing lights	19	Intermittent wiper facility	29	Winter tyres, snow chains	40
Handbrake	20	Heating and ventilation	30	Engine, gearbox oil, battery	41
Brake warning lamp	20	Fresh air blower	30	Spark plugs, handbrake, windscreen and headlight washers ..	41
Steering lock/ignition switch	20	Ventilation	31	Door locks, frosted-up windows	41
4 Starting engine	21	Auxiliary heater	32	Trailer towing	42
		Sliding roof	35		

	Page		Page		Page
Operating instructions		Changing oil filter	62	Fault finding	77
Fuel	44	Additional points to be lubricated	62	Automatic gearbox	79
Filling tank	45	Changing gearbox oil	62	Technical description	
Engine compartment cover	46	Air cleaner	63	Body	84
Checking engine oil level	47	Lifting vehicle	65	Front axle	84
Topping up engine oil	47	Do-it-yourself		Steering	84
Windscreen washer container	48	Wheel changing	66	Rear axle	84
Adjusting windscreen washer jets	49	Spare wheel, tools, jack	66	Brakes	84
Brake fluid reservoir	50	Fuses	69	Transmission	85
Brake servo	50	Relays	69	Engine	85
Wheels	51	Bulb changing	70	Technical data	
Care and maintenance	54	Adjusting headlights	70	Engine	86
Care of car	55	Headlight, side light	71	Fuel consumption	87
Cavity preservation	57	Rear lights, front turn signals, interior light	72	Performance	88
Undercoating	57	Number plate light, masking headlights when going abroad	73	Electrical system	88
Battery	58	Emergency starting	74	Capacities	89
Lubricants		Towing	75	Wheels	89
Engine oil, gearbox oil	59	Service installation of seat belts	76	Weights	90
Lubrication	60			Trailer weights	91
Changing engine oil	61			Dimensions	92
				Identification plate, chassis and engine numbers	93
				Index	94
				Vehicle data quiz	98 5

Instrument panel

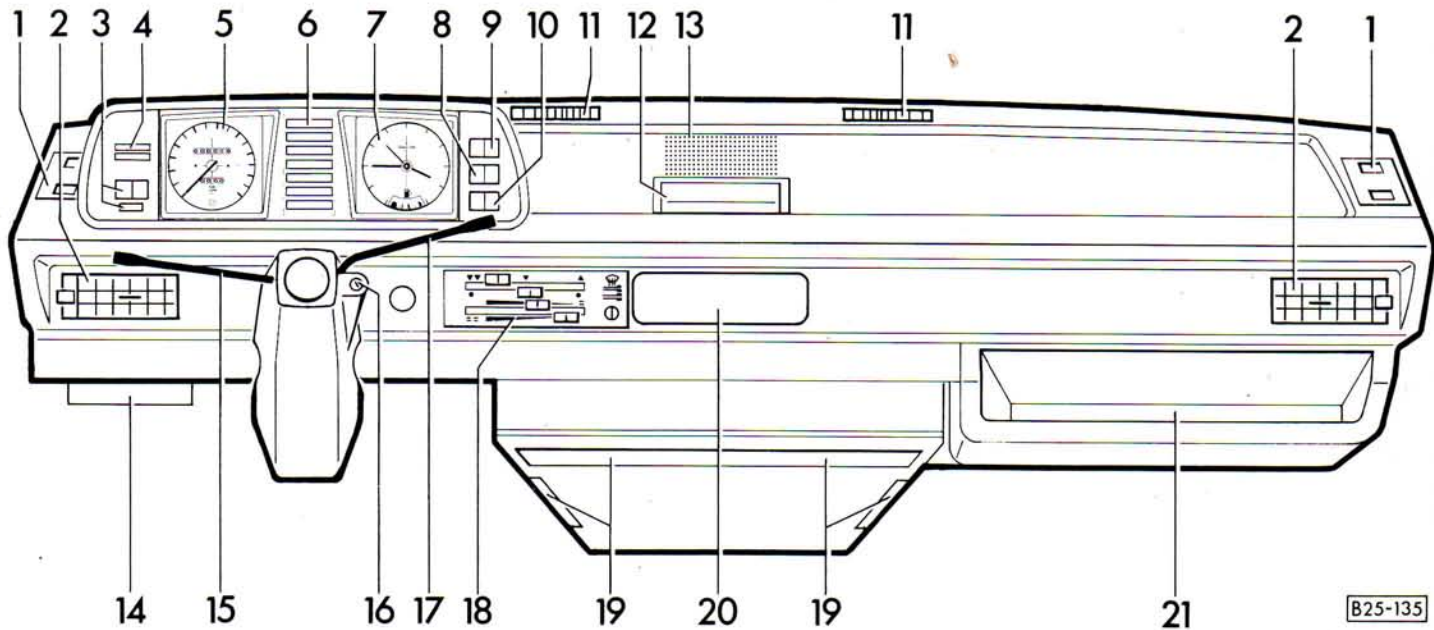

Instrument panel

	Page		Page
1 – Vents for side windows and windscreen	30	11 – Vents for windscreen	30
2 – Fresh air vents	30	12 – Ashtray	35
3 – Lighting switch and instrument lighting rheostat	26	13 – Loudspeaker grille	
4 – Brake warning lamp	23	14 – Fuse box	69
5 – Speedometer with trip recorder	24	15 – Turn signal and dip switch	28
6 – Warning lamps	22	16 – Steering lock/starter switch	20
7 – Clock or instruments	25	17 – Windscreen wiper and washer lever	29
8 – Heated rear window switch	27	18 – Heating and ventilating levers and blower switch	30
9 – Emergency light switch	27	19 – Footwell vents	30
10 – Fog and rear fog light switch	27	20 – Cover plate for radio aperture	
		21 – Glove box	35

The horn is operated by pressing the button in centre of steering wheel.

Operation



Keys

The door and ignition key is a reversible key and cannot be put in the lock the wrong way round. This key is also used for the rear flap.

Vehicles with a lockable glove box or tank cap have additional keys.

The key number is on a plastic tag on the key ring. With this number you can order replacement keys from your V.A.G dealer. When you have noted the number, the tag should be removed so that no unauthorized person can order a key.



Doors

Cab doors

Both cab doors can only be locked from outside with the key. Keyless locking by pressing knobs is not possible.

The locking knobs must go down when doors are locked.

From inside the doors can be locked after closing by pressing the locking knobs down.

When the locking knobs are down the doors cannot be opened from outside.

When vehicle is in motion, the knobs should **not** be pressed down as otherwise the doors cannot be opened from outside in an emergency.

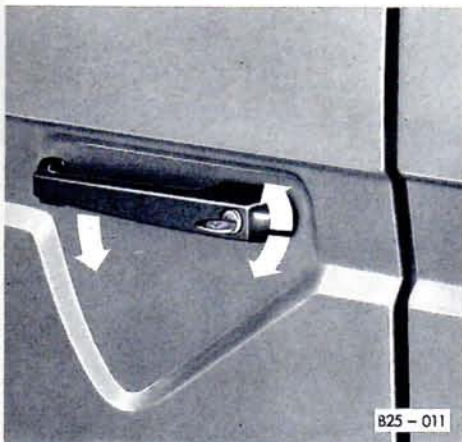

The sliding door can only be locked with the key from the outside.

When fully open, the door is held by a hook.

To close from the outside

Press the door handle down to release the hook and slide the door forwards with momentum.

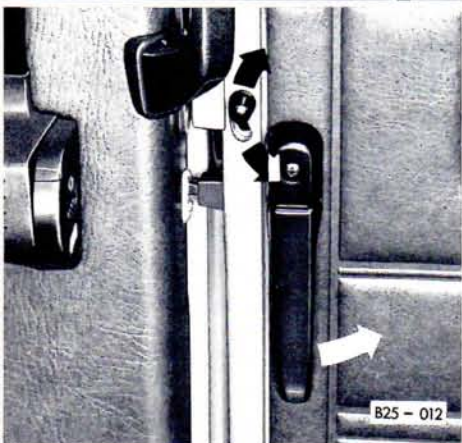

To unlock and lock from the inside

Push locking catch up or down when the door is properly closed.

As long as the catch is in the lower position the door cannot be opened from inside or out.

When the vehicle is in motion, the door must always be properly closed but when carrying passengers the locking catch should be left in the upper position so that the door can be opened from outside in an emergency.

Operation

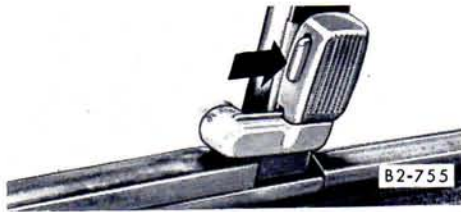

Vehicles with vent wings

To open – Press button in fastener and pivot fastener forwards.

To close – Press vent wing against seal at front then pivot fastener to the rear.

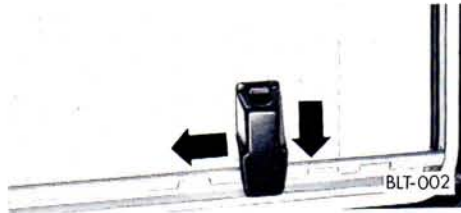

Vehicles with sliding windows

The windows are locked when they are closed. To open them, press the fastener down and slide window along.



Rear flap

To open

Unlock with ignition key, press lock cylinder in and lift flap.

To close

Slam flap down.

After closing the **flap** always pull up briefly on flap to ensure that it is properly closed. **If the catch is not engaged correctly the flap can open suddenly when vehicle is moving – even when the lock has been turned.**

Do not drive with the rear flap open as exhaust gases are then able to enter the vehicle interior.

Before going through an automatic car wash, lock the rear flap otherwise the brushes may press the lock cylinder in and open the flap.

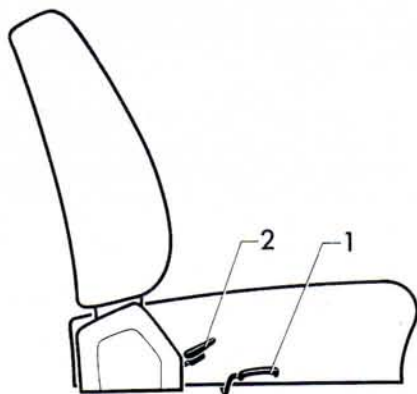

B25-015

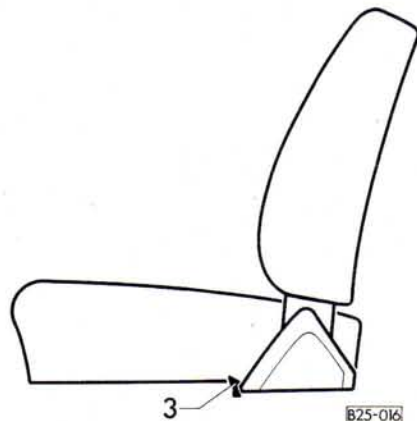

B25-016

Cab seats

To move driver's or front passenger's seat fore and aft (only on vehicles with single seats)

The seat can be moved when lever (1) on left of left seat (right of right seat) is pulled.

- Move seat as required and release lever.
- Move seat further until catch engages in nearest slot.

For safety reasons the seat position should only be adjusted when vehicle is stationary.

To adjust backrest rake

Take weight off backrest, press lever (2) on right side of seat frame down and move backrest to desired position by moving upper part of body then release lever.

To take seat out

- Slide seat forward into 1st latch position.
- Lift hook (3) against spring-loading, at the same time pull lever (1), hold it and slide seat past stop.
- Release hook and lever and push seat forward out of runners.
- The hook need not be lifted when putting seat back as the seat, with the lever lifted, can just be pushed past the stop.

Vehicles with two seater bench

The seat is moved fore and aft in same way as the single seats. The lever is at the front of seat.

When seat is moved, the backrest rake is also altered.

To remove

Remove in same way as the single seats. Bolts on right and left of backrest must be removed.

Swivelling seats

On vehicles with swivelling seats the passenger's seat can be turned 180° to the right and the driver's seat 90° to the left. To turn seats, push them forward slightly or open door. The handbrake must be released before turning driver's seat. (Engage a gear to prevent vehicle from rolling away).

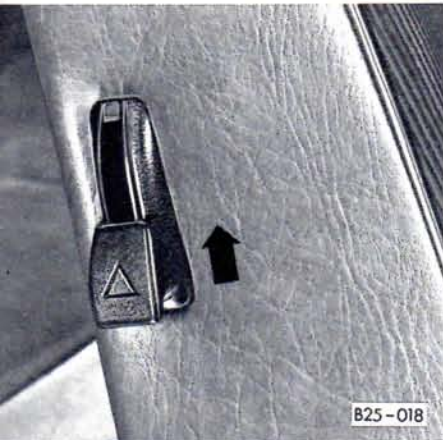

Seats in passenger compartment

Releasing the centre seat backrest

Pull the release knob upwards and push the backrest forwards.

When the backrest is pushed backwards it will automatically lock into position.

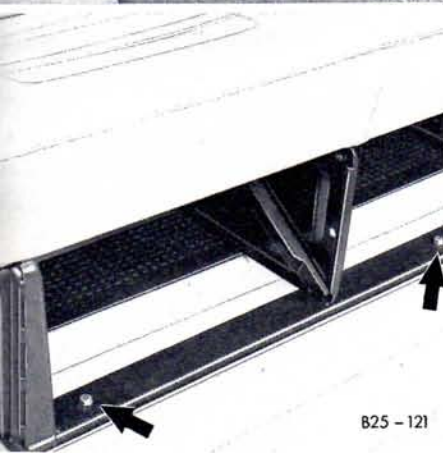

Removing centre bench seat

Remove four wing bolts under seat (the two front bolts are shown in illustration).

The runners must be kept clean, and greased lightly from time to time.

Removing rear bench seat

The rear seat cushion is bolted to the side panels on each side with one bolt under the upholstery. Remove bolts and take lower part of seat out.

The seat backrest is secured at each side with two bolts. The lower bolt also serves as the seat belt anchorage.

When refitting the backrest, ensure that the seat belt is also correctly installed.

B25-121

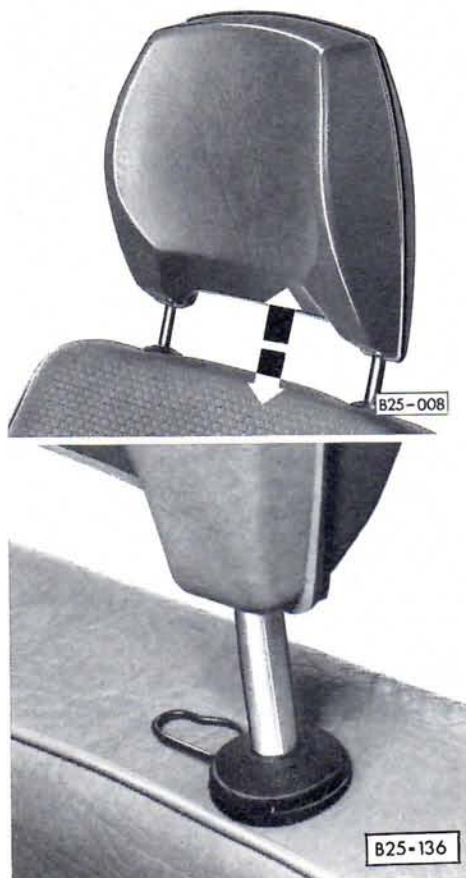

Head restraints

The setting is correct when the upper edge of the head restraint is roughly at eye level.

To adjust head restraint

Grip at sides with both hands and pull up or push down.

To remove and install head restraints

Pull spring clips out of slotted rings in backrest with a small screwdriver and lift head restraint out.

To install, insert head restraint first and then press clips in with straight part at the rear.

Seat belts*

Vehicles with three-point static belts

Putting belt on

Take buckle off hook on door pillar and pass it across chest and hips. Push buckle into the lock part fitted on the seat inner side until it engages audibly.

The belt must fit tightly and not be twisted.

Adjusting belt

Lengthening belt before putting it on

With one hand holding the belt below the adjuster, push the adjuster upwards with the other hand.

Slackening belt when on

Push the adjuster upwards.

Shortening belt

Tilt the adjuster and push it downwards.

After being adjusted, the belt must be pulled tight again.

Taking belt off

Release belt by pressing the orange button marked "PRESS" in the lock. The buckle will then spring out.

Hang the buckle up straightaway on the hook on the door pillar.

* In some export countries the belts used may differ slightly from those described here.

Operation

Vehicles with three-point inertia reel belts

The inertia reel belt adapts automatically to body size and seat position and gives complete freedom of movement when pulled slowly.

Sudden braking will cause the belt to lock. The locking mechanism will also lock the belt when driving down steep gradients or cornering hard.

Putting belt on

Pull the buckle slowly and smoothly across your chest and hips and push it into the lock part belonging to the seat until buckle engages audibly.

The belt must not be twisted

Taking belt off

To release belt, press the orange button marked "PRESS" in the lock. The buckle will then spring out.

Pass the buckle towards the relay fitting on the door pillar so that the retractor can roll the belt up properly. A plastic slide is fitted to hold the buckle in a convenient position. Adjust the slide to suit yourself.

Vehicles with lap belts

The buckle is used in the same way as on the three-point inertia reel belts.

The length of the belt is very important: it must always fit tightly.

To adjust the belt, hold the tongue at right angles to the belt itself and pull the appropriate part of the belt in the required direction.

Adjustment is easier if the lock tongue and cap are pressed together.

The surplus length of belt can be taken up by moving the plastic slide.

otes:

Seat belts are only beneficial if they are worn at all times – particularly in town traffic.

Persons less than 4 ft. 10 in. tall should not wear normal three-point belts – this would increase the danger of injury in an accident.

Children under 12 years of age should always be carried on the rear seat (Combi and buses): Small children in a special seat, older children should have a child's belt. Children over 6 years of age can use a lap belt and children over 4 ft. 10 in. tall can use a normal three-point belt.

Only one person is to be secured with each belt. Never secure two people (even children) with one belt.

Bulky, loose clothing such as an overcoat or jacket impair the belt fitting and therefore its function

The belt should never pass over hard or breakable objects such as spectacles, ball pens, keys, pipe etc., as this could lead to personal injury.

- Ensure that the belt buckle engages properly and that the belt is not twisted.
- The correct adjustment of the static belt length is very important.

The **lap belt** must always fit tightly. This is also valid for inertia reel belts.

The shoulder part must be adjusted so that the hand can just be pushed between belt and chest.

Inertia reel belts adjust automatically.

- When the seat position is altered, the adjustment of the belt must be checked and, rectified as necessary.

- Belts which are not in use should always be hung up on the hooks provided. This will prevent the buckles from swinging about when the brakes are applied suddenly.
- Ensure that the belt does not get jammed between seat and backrest or rub on any sharp edges.
- Do not let the centre seat belts slip down between seat cushion and backrest because belts which cannot be seen readily will not be used by the occupants.
- Seat belts which have been stressed in an accident and stretched must be replaced and the belt anchorages should be checked by a workshop.
- **Keep the belts clean** because they may not retract properly if very dirty (see also section on "Care of car").

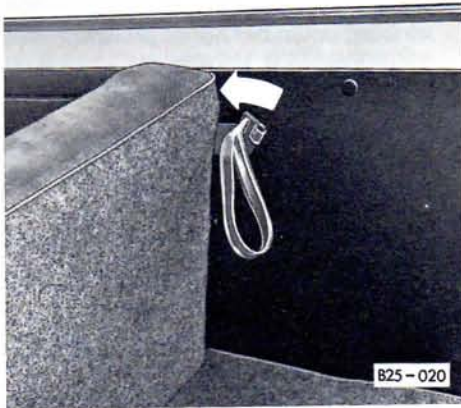

Luggage compartment

The luggage compartment is accessible through the rear flap. See section "Rear flap" on page 11.

Vehicles with hinged rear seat backrest

To enlarge luggage space:

- Release backrest by pulling loop
- Fold backrest down to seat

The backrest locks automatically when hinged to the rear.

When making full use of the load capacity of your vehicle the following should be noted:

- Secure the luggage to prevent it from sliding forward when braking suddenly, and
- Make sure that the heating element of the rear window will not be damaged by cases rubbing against it.

If head restraints are fitted they must be pushed right down before folding the backrest forwards.

On vehicles with three point inertia reel belts for the rear seat bench, ensure that the belts are not jammed when folding the backrest back. It is advisable for this reason to put the belt tongue in the buckle before folding backrest down.

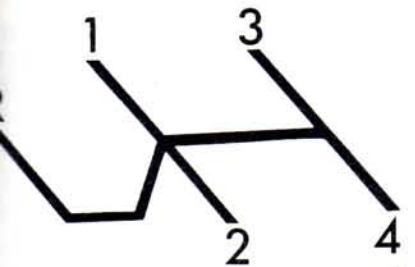

B25-021

Gear lever

Manual gearbox

Select reverse gear only when the vehicle is standing still.

Move lever to the left, press it down and further to the left and then forward.

As the reverse gear is on a separate shaft, grating noises may occur if the gear is engaged too quickly with engine running – particularly when the gearbox is warm.

It is advisable therefore to wait a few seconds with clutch pedal fully depressed, before engaging reverse.

Automatic gearbox

See page 79

Do not make a habit of resting your hand on the lever when driving.

The pressure of your hand is transmitted to the shift forks in the gearbox and can cause premature wear on the forks.

So don't forget – after changing gear take your hand off the lever.

Vehicles with reversing lights

The lights come on when reverse is engaged with ignition on.

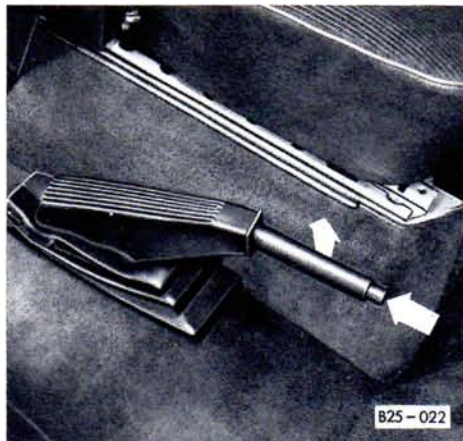

Handbrake

Always apply handbrake firmly so that you cannot drive off with the handbrake on slightly.

To release handbrake – pull lever up slightly, press in the locking knob and push lever right down.



Steering lock/starter switch

Key positions:

1 – Ignition off

To **lock the steering** withdraw key and turn wheel until you hear the pin engage.

Do not withdraw key until vehicle is stationary.

2 – Ignition on

(see “Warning lamps” and “Instruments”)

On vehicles with a **brake warning lamp** the lamp should go out when the handbrake is released, with the engine running (see “Warning Lamps”).

If the key is difficult to turn to this position or cannot be turned at all, move the steering wheel to and fro slightly to release the locking pin.

3 – Starting (see page 21)

In this position the current to the headlights, windscreen wipers, blower and heated rear window is interrupted.

Starting the engine

Be careful when running the engine in a confined space. Danger of poisoning.

Check that gear lever is in neutral. (On vehicles with automatic gearbox: Selector lever at "P" or "N") and apply hand-brake before starting.

Depress the clutch pedal when starting so that the starter only has to turn the engine.

As soon as the engine starts, release the ignition key so that the starter can disengage.

Before the starter can be operated again the key must be turned back to position 1. The non-repeat lock in the ignition switch prevents the starter from being operated when the engine is running as this could damage the starter.

Do not try to warm engine up by running it with vehicle stationary. Drive off straight away.

- **Only when it is very cold** is it advisable to let the engine run for about 30 seconds at a fast idle before moving off. This gives the lubrication system time to circulate the oil properly.
- On vehicles with an automatic gearbox, run engine at a fast idle for about 1 minute before selecting a gear. The increase in the idling speed which takes place as the engine starts to warm up can be reduced by just tapping the accelerator pedal briefly.
- On vehicles with the 37 kW engine, the engine may rattle briefly after being started. This is caused by the hydraulic tappets which have to build up to a certain oil pressure first. The noise is harmless and no cause for alarm.

- **At temperatures above freezing point**

Depress accelerator pedal slowly while operating the starter.

- **At temperatures below freezing point**

Before operating starter, depress accelerator pedal fully once and let it return slowly – this actuates the automatic choke.

- **When engine is very warm**

Depress accelerator pedal fully while operating starter but do not "pump" the pedal.



Turn signals and



Main headlight beams
see page 28

Warning lamps



Oil Pressure

The lamp comes on when ignition is switched on. It should go out again when engine is started.

If the oil pressure warning lamp comes on or flickers when driving:

- Stop straightaway, switch engine off and check oil level (see page 47).
- If the cause of the trouble cannot be found, you must obtain expert assistance on the spot.
Occasional flickering of the lamp at idling speed after a long spell of fast driving is no cause for alarm as long as lamp goes out when engine speed is increased.



Generator

The lamp comes on when the ignition is switched on. It should go out again when the engine is started

If this lamp comes on when driving:

- Stop engine, check belt and fit new if necessary. Without a belt the vehicle must only be driven slowly (max 50 kph) to the nearest V.A.G workshop because the heater blower is not being driven and heat build up can damage the heat exchangers. It is advisable to carry a spare belt on the vehicle at all times (see page 88). The battery will also be discharging continuously.
- If the belt is in order, the trouble may be due to a faulty generator.

If the trouble cannot be put right on the spot one can also drive to the next V.A.G workshop but remember that the battery will be discharging continuously.

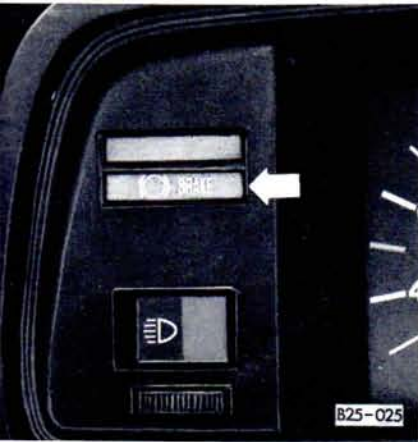

(⊙) Brake system

On vehicles with a brake warning lamp the lamp should come on when the ignition is switched on and go out after the engine has been started and the handbrake released. If the light does **not** come on when the ignition is switched on the cause of the trouble must be found and rectified as soon as possible so that the light can fulfil its warning function.

If the light comes on when the brakes are applied, it could mean that one of the two brake circuits has failed.

You can drive on to the nearest V.A.G workshop but allow for reduced braking efficiency, higher pedal pressures and longer braking distances on the way.

Operation

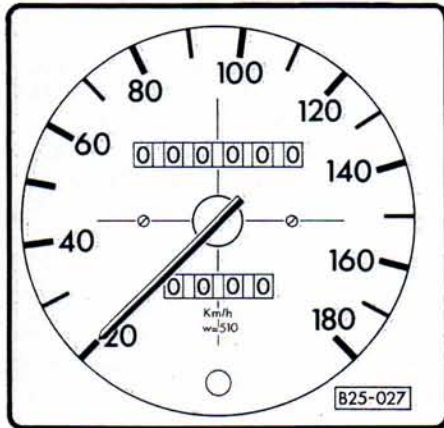

Instruments Speedometer

Permissible speed ranges for the various gears in km/h:

	37 kW	51 kW
1st gear	0–20	0–25
2nd gear	15–40	15–20
3rd gear	25–70	25–85
4th gear	40–to top speed	40–to top speed

The white roll with red figures records 100m or 1/10 mile.

Vehicles with trip recorder

The trip recorder is zeroed by pressing the knob below the speedometer.

Gear shift points on speedo dial:

- The marks apply only when the engine is warm.
 - The arrangement of these marks is determined by the type of engine fitted.
 - The **next higher** gear should be selected, at the latest, when the needle has reached the mark.
- Changing up early helps to save fuel and keeps the noise down.**
- The **next lowest** gear should **only** be selected at the earliest, when the vehicle speed has dropped below the marking.

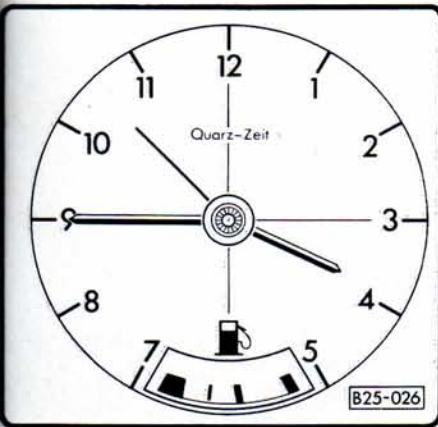

Fuel gauge

The tank holds about 60 litres (13 gallons). When the needle reaches the start of the reserve mark there are about 2 gallons (10 litres) of fuel left in the tank.

The fuel gauge starts to work when the ignition is switched on but it takes a few seconds for the needle to reach its final position.

Vehicles with a clock

The clock is electrically operated. The hands can be moved by pressing in and turning the knob in the dial centre.

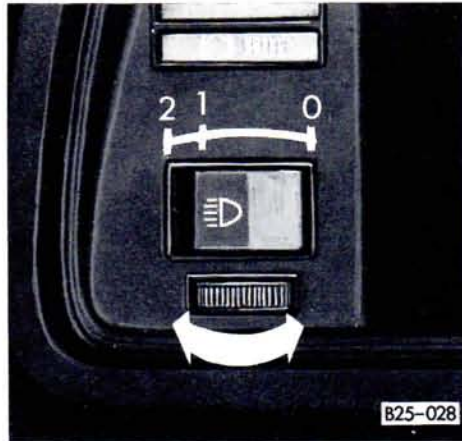

Lighting switch

Parking lights – 1st detent

Driving lights – 2nd detent

The headlights only work when the ignition is on (key in Drive position). When the starter is being used, the headlights are switched off automatically.

When the lights are switched on the brightness of the instrument panel lights can be regulated by turning the switch on vehicles with variable instrument panel light.

Dipping headlights – see page 28.

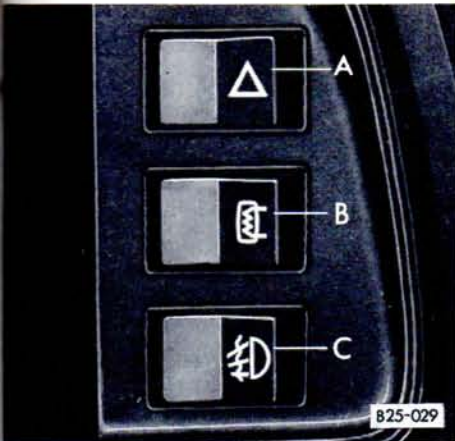

C – Emergency light switch*

When the emergency lights are on, a warning lamp in the switch flashes as well.

B – Rear window switch

The heater element only works when the ignition is on. (Ignition key in drive position.)
When heater element is on a warning lamp in the switch lights up.

D – Switch for foglights*/rear foglight*

Foglights – first detent
Fog **and** rear foglights – second detent
In both positions a warning lamp in the switch lights up.
On vehicles **without** foglights the rear foglight comes on at the first switch position.

As soon as window is clear switch element off to reduce current consumption.

The **foglights** come on with the side or driving lights when ignition is on.

The **rear foglight** comes on only when the foglights or driving lights are on.

* Please note the local regulations on the use of these lights in your country.

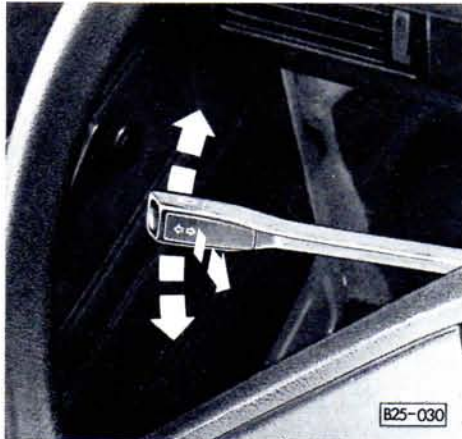

Turn signal and dipper lever

The turn signals only work when the ignition is on.

- Centre position – off
- Lever up – Right turn signals
- Lever down – Left turn signals

The turn signals are self-cancelling

When a turn signal fails, the warning lamp flashes faster.

To signal a lane change

Move lever up or down until resistance is felt and hold it in this position – the warning lamp must be flashing.

When released, the lever springs back to the centre position.

Dipping

When vehicle lights are on pull lever past pressure point towards steering wheel.

When headlights are on high beam, a warning lamp comes on.

Headlight flasher.

Pull lever up to **pressure point** towards steering wheel. The high beam warning lamp comes on.

The flasher does not work when high beams are on.

Vehicles with parking lights

Ignition switched off:

- Lever up – right parking lights
- Lever down – left parking lights

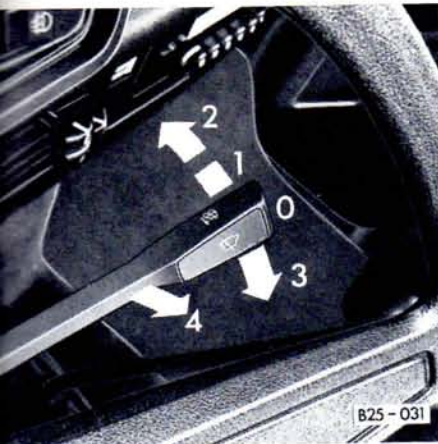

The windscreen wipers and washer only work when ignition is switched on.

Note

In the winter please ensure that the wiper blades are not frozen to the glass as otherwise they will be damaged when the wipers are switched on.

Windscreen wiper and washer lever

Wipers and washer off:

Lever at position 0

Brief wipe:

Move lever up to pressure point of 1st stop. The wipers work as long as lever is held in this position.

Wipers slow:

Lever at 1st stop.

Wipers fast:

Lever at 2nd stop.

Windscreen washer:

Lever at position 4.

Washer works as long as lever is held in position.

On vehicles with automatic wash/wiper and intermittent wipe facility:

Automatic wash/wipe:

Move lever to position 4 – washer and wipers work

Release lever – Washer stops and wipers continue for about 4 seconds.

Intermittent wipe:

Lever at position 3.

Wipers work about every 6 seconds.

Vehicles with headlight washer

When the headlights are on, the lenses are washed every time the windscreen is washed.

At regular intervals, such as when filling tank with fuel, caked-on dirt (insects etc) should be removed from the lenses.

Filling the washer container is described on page 48.

Operation

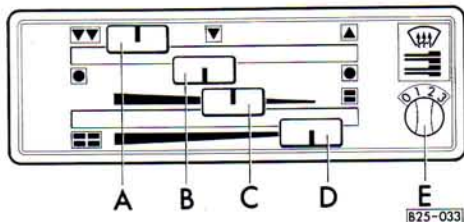

Heating and ventilation

Heating

A – Warm air distribution lever

Lever to right

– Warm air from windscreen vents and side vents F.

Lever in centre

– Warm air from cab footwell vents and side vents F.

Lever to left

– Warm air from footwell vents in cab and passenger compartment and side vents F.

B – Heat control lever*

Lever to right – increases heat

Lever to left – reduces heat

Defrosting windscreen

- All levers fully to right.

Ventilation

C – Fresh air lever

Fresh air from windscreen defroster vents and footwell vents.

Lever to right –

Reduces amount of air

Lever to left –

Increases amount of air

On vehicles with 3 levers for heating and ventilation and roof vents in the passenger compartment the roof vents are also supplied with fresh air.

D – Lever for roof vents in passenger compartment (only on model with 4 levers)

Lever to right –

Reduces amount of air

Lever to left – Increases amount of air

E – Rotary switch for three-speed blower (Optional equipment)

When driving slowly, the blower should be used to increase the flow of air.



F – Warm air vents for side windows

G – Fresh air vents

Lever down – Vent open

Lever up – Vent closed

The air flow can be directed up or down (c) by swinging the complete grille.

Moving the lever in the grille to or fro changes air flow sideways (d).

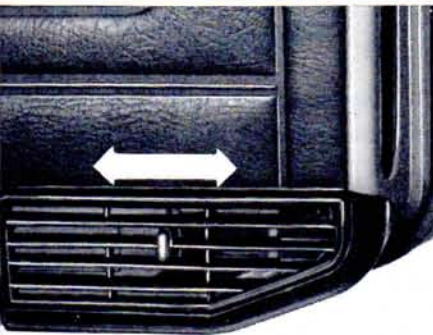

Ventilation

Stale air can escape through grilles in the cab doors. The flow can be regulated with slides

Slide forward – Grille open

Slide to rear – Grille closed

B25-035

Operation

Vehicles with Auxiliary Heater BA 6

The heating system consists of the engine heating and a gasoline heater booster.

In this system the fresh air is prewarmed in the engine heat exchangers and then heated up in the heater.

The heater is supplied with fuel from the vehicle tank. It can use up to one liter per hour according to operating conditions.

The temperature of the warm air can be regulated and is kept constant electronically. This means that the heater produces a varying amount of additional heat according to the engine temperature. The heater cuts out altogether temporarily when the engine is capable of supplying the desired amount of heat on its own, for example, when driving fast on a motorway. When the engine is not running the heater works alone.

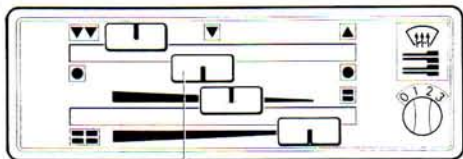

B

B25-078

Heating control lever – B

Lever to left – Heating system off

Lever halfway to right – Engine heating on

Lever fully to right – Gasoline heater also ready to be switched on



Temperature regulating switch

This switch is used to switch heater on and regulate amount of heat.

Heating when driving

To switch on:
Push lever B fully to right.

Turn temperature regulating switch clockwise to position 1 (lamp lights up) and set amount of heat required between 1 and 2.

To switch off:
Turn temperature regulating switch anti-clockwise to 0 (lamp goes out) and move lever B to left.

Heating with engine not running

To switch on:
Push lever B fully to right.
Press temperature regulating switch in at 0 and turn clockwise as far as it will go (lamp lights up). The knob springs out again when released. Set heat required between 1 and 2.

To switch off:
The clockwork in the temperature regulating switch switches the heater off automatically after about 10 minutes and the lamp goes out.

To switch heater off before clockwork has run down:

Turn temperature regulating switch anti-clockwise to 0. The lamp goes out and clockwork runs down.

When the heater is running on the clockwork time switch, it must be switched off by hand before attempting to start the engine at low temperatures so that the full battery capacity is available to turn the engine. When the clockwork has run down, the heater is switched off automatically when the starter is being operated.

Every time the heater is switched off, the warm air and combustion air blowers continue running briefly to cool the heater down quicker.

To avoid draining the battery, do not run the heater repeatedly when the engine is not running.

In enclosed spaces and when filling the fuel tank, the heater must be switched off.

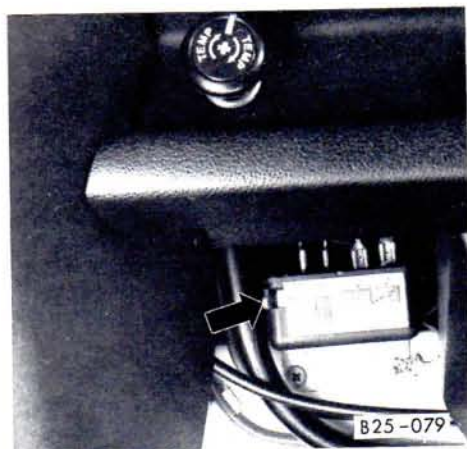

Heater safety switch

The heater has a safety switch which is located under the dash on the left near the steering column. If the heater does not start some time or starts and then goes out again, wait 3 minutes and then operate the red lever on the safety switch.

If the heater still does not work or if the safety switch stops it again, there is a defect in the heater which can only be repaired by a V.A.G workshop.

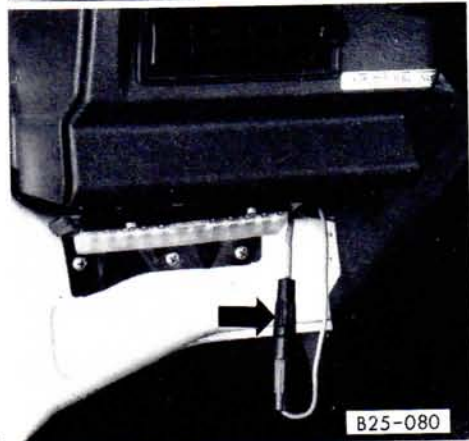

Fuses

There are 3 fuses for the heater system: A 16 Amp. fuse in the fuse box (Nr. 10) for the control.

An 8 Amp. overheating protection fuse in a separate holder on the right of the main fuse box.

A 16 Amp. fuse for the blower under dash (in wire). See illustration.

For instructions on changing fuses, see "Fuses" in the "Do-it-yourself" section.

Maintenance

When driving through mud and snow, the exhaust pipe may tend to get blocked. Have a look at it occasionally to see that it is clear.

According to official regulations:

The heat exchanger in the heater is only to be used for 10 years. After this period the heat exchanger must be replaced in a V.A.G workshop. The year in which the heater is first put into operation is marked on the nameplate on the heater. The V.A.G workshop must fit a plate showing the date of the repair and bearing the words "Genuine service part".

Vehicles with sliding roof

To open sliding roof

Fold crank down and turn anti-clockwise.

To close sliding roof

Turn the crank clockwise until it comes to a stop, then turn it back slightly until it can be folded into the recess.

For safety reasons the crank should always be folded into the recess.

Sun visors

Both sun visors can be lifted out of their brackets and swung round towards the doors.

On vehicles with a make-up mirror the mirror is fitted in the passenger's sun visor.

Ashtrays

Ashtray in dash

To take out:

Grip the strip on opened lid and lift at one side to take out.

To insert:

Press ashtray into opening with lid closed.

Ashtray in passenger compartment

To take out:

Open ashtray, press down and take out.

To insert:

Insert at top first then push in fully.

Glove box

Vehicles with a lockable glove box have an additional key.

Vehicles with socket/cigarette lighter

The **socket** can be used for other electrical accessories with a capacity of up to 100 Watts. Please bear in mind however that the battery will soon be discharged when engine is not running.

Push in **lighter knob**. The lighter springs back automatically when the coil is hot.

Then use the lighter immediately because the coil cools down quickly.



Front interior light

Switch positions:

Front – Door contacts, light comes on when driver's door* is opened.

Centre – Off

Rear – Light on all the time.

* Passenger door as well on some models.

Rear interior light

Switch positions:

Up – Door contacts, light comes on when the sliding door or on some models the front doors, are opened.

Centre – Off

Down – Light on all the time.

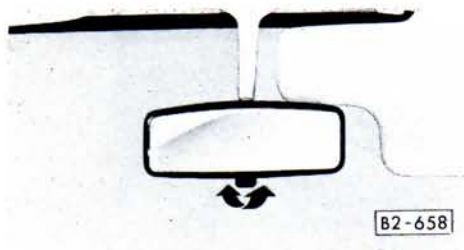

Interior mirror

On vehicles with an anti-dazzle mirror there is a small lever on the mirror:

Normal position – Lever forward

Anti-dazzle position – Lever to rear

For safety reasons the mirror springs out on impact.

It can be installed again by pressing it in firmly.

Cover (Pick-up)

Ensure that the cover is secured properly behind the cab.

The cover is correctly secured when the rod incorporated in the cover engages in the rain channel at the rear of the cab and the left and right hand ends are bolted to the canopy frame.

Loading limit

When stowing cargo, ensure that door/flap is not obstructed.

The first 1000 km – and afterwards

Careful choice of materials, quality workmanship and modern production methods guarantee the high precision and smooth operation of all the engine components. Nevertheless, during the first few hours of its working life the engine will be more subject to the effects of internal friction than later on when all the moving parts have bedded down. How well the parts bed down depends primarily on the way you drive during the first 1000 km or so.

Do not drive at full throttle during the first 1000 km.

Varying the engine speed and the load on the transmission will help to produce a well run-in vehicle.

The following points apply to new **and** run-in vehicles:

- Never over-rev a cold engine – either in neutral or in the gears.
- Letting the engine labour is just as bad as thrashing it at full revs.
- Never let vehicle labour up a gradient with the accelerator pedal pressed right down; change down a gear or two in good time. During the running-in period you should make especially good use of the gearbox.
- Changing up in good time helps to save fuel and keeps the noise down.
- The permissible speeds in 1st, 2nd and 3rd gears when vehicle is run in are marked on the speedometer dial. The gears should be changed at the latest by the time these speeds are reached so that the permissible engine speeds are not exceeded.

Driving safely

The following points are of particular importance to safe operation of the vehicle.

Tyres

- New tyres do not give maximum grip straightaway and should therefore be run in at moderate speeds for about the first 60 miles (100 kilometers). This will help to make the tyres last longer.

Brakes

- Brake linings must bed themselves in and do not have the maximum frictional properties at first. To compensate for the slightly reduced braking effect, be prepared to use more pressure on the pedal during the first 300 miles (500 km). This also applies when new linings have been fitted.
- Use engine braking when going down steep hills: Change down before starting to go down the hill and use brakes as a reserve. When brakes are applied, do not keep them on continuously, apply and release alternately.
- After driving through water, driving in heavy rain or washing the car, the braking effect can be retarded slightly: The linings must be dried out first by applying the brakes.

- Brake lining wear depends to a large extent on the operating conditions and style of driving. On vehicles which are used mainly in town traffic under stop/start conditions or are driven hard it may be necessary to have the thickness of the brake linings checked in a V.A.G workshop in between the normal visits to the workshop.

- **The movement of the pedals, particularly the brake pedal, must not be restricted in any way.**

If trouble occurs in the brake system, the full range of pedal movement may be required. For this reason, floor mats etc. should not be placed in the footwell if they are likely to interfere with pedal travel.

Do not put articles in the footwell which could roll or slide under the pedals when the brakes are applied.

- If the pedal travel increases suddenly, it may be that one of the two brake circuits has failed. On vehicles which are fitted with a brake warning lamp, the failure of a brake circuit will also be shown by the lighting up of the warning lamp when brakes are applied. You can still drive on to get to the next V.A.G workshop but be prepared to use more pressure on the pedal and allow for longer braking distances on the way.

On vehicles with a brake warning lamp (see also page 23), the failure of a brake circuit is also shown by the lighting up of the lamp.

Driving economically

The technical conditions for low fuel consumption and economy are built into your vehicle at the factory. It is now up to you to maintain these properties:

- Have your vehicle serviced in a V.A.G workshop at the intervals laid down in the Service Schedule. You will then obtain optimal economy plus constant reliability and long service life.
- Check the tyre pressures at regular intervals. Low tyre pressures are not only detrimental to handling, the higher rolling resistance increases the fuel consumption.
- Do not drive about unnecessarily with a roof rack or ski brackets on the vehicle. Particularly at high speeds the increased air resistance makes itself felt.
- Do not carry a lot of unnecessary ballast about in the luggage compartment. Particularly in town traffic when vehicle is being frequently accelerated the vehicle weight has a considerable influence on fuel consumption.

Economy depends also on the personal style of driving: If you wish to drive economically, that is to keep fuel consumption and brake lining and tyre wear to a minimum, avoid high speeds and full throttle acceleration and drive smoothly and carefully.

The individual conditions in which the vehicle is used also have an influence on fuel consumption and the driver can do little to alter these factors. The following factors for instance are not favourable to fuel consumption:

- Traffic density, particularly large towns where there are numerous traffic lights.
- Stop-start driving, such as driving from house to house so that the engine is never properly warm.
- Condition of road surface, particularly loose sand and snow.
- Driving in columns of vehicles in low gear so that the engine speed is relatively high (in relation to the distance covered).

Good consumption figures can be obtained when driving for long distances at medium speeds and medium engine speeds with few stops.

Engine oil consumption is also largely dependent on the way you drive, i. e. on engine load and engine speed. Depending on the way you drive, oil consumption can be up to 4 pints per 1000 miles (1.4 l/1000 km).

It is well known that a new engine does not give its most favourable oil consumption until after a certain period of operation. Because of this, oil consumption cannot be judged accurately until after about 3000 miles (5000 km). Up to then the consumption may be somewhat higher than indicated in the previous paragraph.

The fuel consumption and engine performance can also not be correctly assessed until this distance has been covered.

Winter driving

The vehicle will always be ready for use in snow and ice if a few simple measures are taken to "winterproof" it before the cold weather starts.

Air cleaner / intake air preheating

The intake air preheating is controlled automatically and no "winter measures" are necessary on the air cleaner.

Fuel

At ambient temperatures between 0° C and 15° C, carburetor icing can occur when the air humidity is high even though the intake air preheating system is working properly. The result is that the engine tends to stall at idling speed during the warming-up phase.

Even the anti-icing additives contained in some fuels in the cold season cannot entirely prevent carburetor icing.

When a properly tuned engine stalls repeatedly in the conditions described above it is advisable to mix **Volkswagen Audi Petrol Additive** with the fuel. This additive is obtainable from V.A.G workshops in Germany and in many export countries under the Part No. AOS 150 000 03.

Winter tyres

only have advantages when road conditions are really wintry. Vehicles fitted with radial ply tyres can often manage without winter tyres if conditions are not too severe.

If vehicles fitted with radial ply tyres at the factory are equipped with winter tyres only radial ply winter tyres should be used.

When fitting normal winter tyres (cross ply), note the PR figures on the tyre walls. The specified carcass strength (PR number) must be adhered to.

Winter tyres must always be fitted on all four wheels.

Due to the specific characteristics of winter tyres, it is necessary to inflate them to 0.2 bar (3 psi) above the pressure for normal tyres.

Winter tyres are no longer fully effective when the tread has worn down to a depth of 4 mm.

Snow chains

Thin chains which do not stand clear of the tread more than 15 mm, including tensioner, can be used on the driving wheels. (Rear wheels)

When driving over long stretches of road which are free of snow, the chains should be removed. On dry roads the chains wear very quickly and can damage the tyres as well.

Engine oil

tends to thicken at low temperatures and may cause starting difficulties. As soon as winter temperatures are expected, change over in good time to a thinner grade of oil. If you use multigrade oil you should not need to change to a different grade.

The various viscosity grades are described under "Lubricants".

Hypoid gear oil (Manual gearbox)

The SAE 80 or SAE 80 W-90 hypoid gear oil to Mil-L-2105 API/GL 4 specifications is used all the year round.

Lubrication of the automatic gearbox is described in the section "Automatic gearbox", paragraph "Lubrication".

Battery

A really cold battery has only a fraction of its normal capacity, particularly if it is not fully charged to start with. In order to ensure that the engine starts readily in all conditions have battery checked at a V.A.G workshop frequently and charged if necessary.

The spark plugs

should not have excessively large gaps, particularly in the winter. The correct gap is 0.6–0.7 mm.

Handbrake

If there is a danger of frost, do not apply the handbrake but engage 1st (automatic gearbox: range "P") or reverse gear instead. Brake linings which have become wet due to splashing or condensation can freeze on to the drums in the winter when the handbrake is left on. When parking on steep hills, turn the front wheels in towards the kerb as well.

The windscreen and headlight washer

can be frostproofed and kept working by the addition to the water of a large dose of window cleaner solution with an anti-freeze agent.

Door locks

can freeze up if water gets into the cylinder when the vehicle is washed, for instance, so do not aim the water jet directly at the locks. It is a good idea to cover up the keyholes beforehand. A frozen door lock can be thawed out easily, even when it is very cold, with the help of a lock defreezing agent.

Frozen windows

can be cleared with defroster spray. After the spray has worked for a short period, the ice can be wiped off.

It is a good idea to carry a shovel or a short-handled spade in the car during the winter so that you can clear away snow if you get stuck. A small hand-brush for sweeping snow off the vehicle and a plastic scraper for the windscreen are also useful.

Trailer towing*

If you are going to tow a trailer with your vehicle, it must be specially equipped for this purpose.

When a new vehicle is **ordered with a towing bracket**, the following is taken into account:

- The towing bracket and the electrical connections for the trailer are installed correctly.
- In Germany the vehicle documents are endorsed.

When a towing bracket is **service installed**, the following should be noted:

- The towing bracket is a safety part. Only a bracket which has been developed for your vehicle is to be used and it must be fitted in accordance with our instructions. Details are usually given in the fitting instructions supplied with the bracket.
- A special warning lamp must be fitted within the driver's range of vision to show that the trailer turn signals are working.

The service installation should preferably be carried out by a V.A.G Dealer.

Please note the following points:

- One pin in the 7 pin trailer socket on the vehicle is usually left free (terminal 54 g). This can be used to connect additional electrical components in the trailer to the vehicles electrical system.
- If traffic conditions behind the trailer cannot be seen properly with the normal mirrors, outside mirrors mounted on folding extendable arms should be fitted.
- Ensure that the tyres have good treads and that the inflation pressures are correct. If the vehicle is fitted with winter tyres, trailers with brakes should also be equipped with winter tyres.
- The fitting of a towing bracket increases the weight slightly so that the payload must be reduced correspondingly.

Towing a trailer places a considerable strain on the body, transmission, clutch and brakes of the towing vehicle.

In order to avoid damage to the towing vehicle, please note the following instructions and driving rules.

- Do not exceed the maximum trailer weight specified for the vehicle (see Technical Data).
- The weight of the trailer draw bar on the ball of the towing bar must not exceed 50 kg (110 lbs). The permissible rear axle load must not be exceeded.

The minimum nose weight must not be less than 4 % of the actual trailer weight but it need not be more than 25 kg.

- Use the clutch carefully when towing. Do not accelerate more than necessary when moving off and never slip the clutch longer than necessary.
- Always drive at a moderate speed. In many countries there are speed restrictions for vehicles towing trailers.
- Use brakes in good time and as gently as possible. Practise braking properly with a trailer with over-run brakes: Apply brakes gently at first then increase pressure quickly. In this way you can avoid the jerking which is caused by locked trailer wheels.
- Change down in good time before going downhill.

- Trailer towing always puts the fuel consumption up. This is due to the extra weight and the higher rolling and air resistance.

The following points should be noted when towing a trailer in mountainous regions:

- The trailer weights given in the "Technical Data" section in conjunction with the 16 % gradient are only applicable up to an altitude of **1000 m** above sea level.

When driving above **1000 m**, the engine output and thus the climbing ability decreases due to the lower air density. The maximum combined weight (vehicle and trailer loaded to permissible total weight) given for altitudes up to 1000 m must therefore be reduced by 10 % for each further 1000 m if the gradients mentioned above are to be climbed.

If the combined vehicle and trailer weight is below the permissible maximum a correspondingly steeper gradient can be climbed.

Operating instructions

The condition of a car is closely bound up with road safety.

So before driving off check the following:

the fuel level

the lights and turn signals

the brakes

the windscreen washer

and at regular intervals

the engine oil level

the brake fluid level

the tyre pressures

You will have less to worry about while driving!

Type of fuel

The 37 and 51 kW engines: Regular petrol; RON* not lower than 91.

If regular petrol with adequate anti-knock properties is not available, use premium petrol or an appropriate mixture.

Additives

should not normally be put in the petrol.

Only if the engine tends to stall repeatedly when warming up in the cold season due to carburetor icing, do we recommend that **Volkswagen AUDI Petrol Additive** is mixed with the petrol.

Further details are given in the section on "Driving in winter", page 40.

* RON – indicates anti-knock properties of the petrol.



Filling tank

The filler neck is at the front on the right hand side of the vehicle.

Vehicles with a lockable tank cap have a special key.

Trouble-free refueling calls for correct use of filler pistol.

- Insert nozzle fully into tank neck and do not tilt it.
- Do not try to fill tank too quickly, otherwise the fuel will foam and this may cause pistol to switch off too soon.

The fuel tank capacity is approx. 60 litres, of which approx. 10 litres are reserve.

"Fuel gauge", see section "Operation".

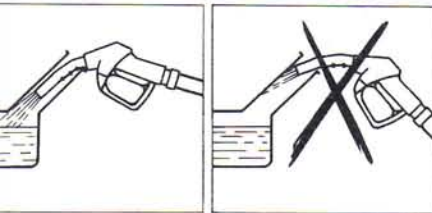

B5-391



Engine compartment cover

The cover is in the luggage compartment. To remove it, turn the two catches to the left.

On the Pick-up, the cover is in the rear panel.

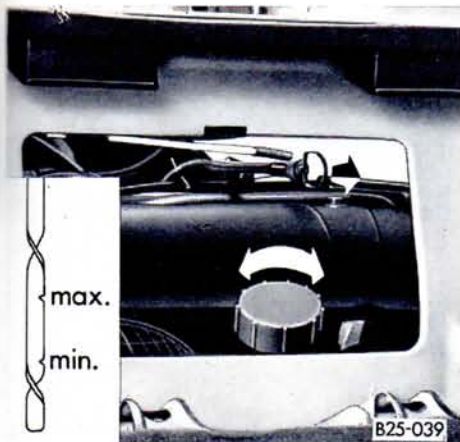

Engine oil level

The engine oil level should always be between the two marks – max/min – on the dipstick and must never be below the min mark.

Checking oil level

The dipstick and filler pipe can be reached through a flap behind the rear number plate.

The vehicle must be on a level surface when the oil level is checked. Do not check the oil immediately after stopping the engine, as the oil in circulation takes a few minutes to drain down into the sump.

Pull the dipstick out and wipe it with a clean cloth. Push the dipstick in fully, pull it out again and check the level.

The difference in quantity between the min. and max. marks is:

37 kW engine – 1.0 l (1.75 pints)

51 kW engine – 0.6 l (1.0 pint)

If the level is down to the MIN mark, it is not necessary to top up right up to the MAX mark. Add sufficient oil to ensure that the vehicle will run to the next oil level check without the level falling below the min. mark.

Permissible oil consumption, see "Technical Data".

Topping up

Unscrew the cap from the oil filler and pull extension pipe out fully.

Add oil.

Check the level with the dipstick – the oil should not be above the max. mark. Push extension pipe in again and screw the cap back on tightly.

Notes on the use of oils of different types and viscosity grades are given under "Lubricants".

When engine is working hard, the oil level should be kept near to the max. mark.



Windscreen washer container

The filler opening of the container is under the carpet on left hand side of front footwell. The container holds about 3.5 litres. On vehicles with a headlight washer the capacity is 6.5 litres.

To fill container

Lift carpet, open flap and unscrew cap. Fill container to top with water and screw cap on again. Switch ignition on and check that washer is working.

We recommend that you always add a window cleaner fluid to the water since water on its own is not usually sufficient to get the windscreen and headlight lenses really clean in a short time.

See "Winter driving", page 41.

Adjusting the windscreen washer jets

The illustration shows where the water should spray on to the windscreen when the vehicle is **stationary**, so that the windscreen will be washed properly even when the vehicle is travelling at high speed.

A needle can be used to adjust the jets.

- a = 465-516
- b = 195-245
- c = 165-215
- d = 305-355

B25-043

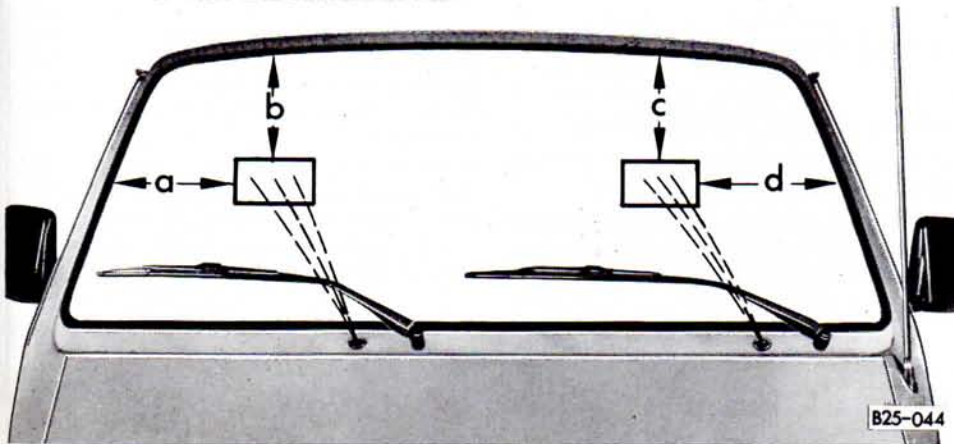

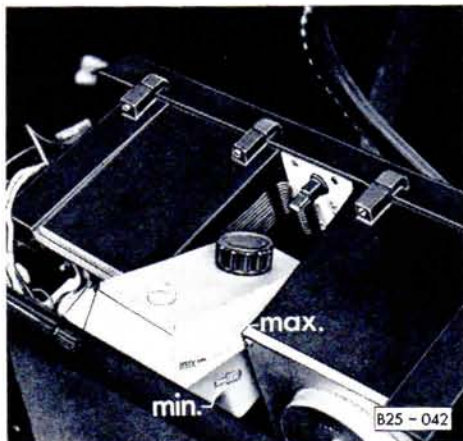

Brake fluid

Brake fluid is hygroscopic. As too high a water content in the brake fluid becomes detrimental to the entire system after a period of time, the brake fluid must be renewed every two years. The brake system must be bled afterwards.

Use only fresh (unused Volkswagen/Audi brake fluid which complies with US FMVSS 116 DOT 3 specifications to fill the system. This brake fluid is available in all V.A.G workshops.

Caution:

Brake fluid will damage paintwork and the plastic material of which the dash is made. Take great care not to spill any fluid when topping up the reservoir. Cover area round reservoir if necessary.

Vehicles with brake servo

The servo is operated by vacuum which is only available when engine is running.

When vehicle is rolling or being towed with the engine not running, the brake pedal must be pressed harder.

Brake fluid reservoir

The brake fluid reservoir has two chambers, one for each of the brake circuits.

The screw cap for the common filler opening has a vent hole. This hole must always be kept clear.

The reservoir is made of transparent material so that the level of the brake fluid can be checked easily. The level should always be between the maximum and minimum marks.

The level of the fluid tends to sink slightly when the vehicle is used due to the automatic adjustment of lining wear which takes place. This is quite normal.

However, if the level sinks noticeably in a short time this indicates that fluid is being lost somewhere in the system due to leakage. You should then take the vehicle to a V.A.G workshop at once and have the brake system checked.

The fluid reservoir is in the dash under the dash cover panel. The panel can be lifted to fill the reservoir. To do this grip in the recess at the back of the cover. When installing insert the lower front edge first.

Wheels

Wheels and tyres are important design features. The wheels and tyres approved by us are specially matched to the model concerned and contribute largely to the excellent roadholding and safe driving characteristics.

Before fitting any non-standard wheels or tyres to your car, have a word with your V.A.G dealer.

Using types of wheel and/or tyre which have not been approved by us can affect the vehicle under the Construction and Use regulations.

See "Wheel changing".

Here are a few general notes on tyres

New tyres

- New tyres can be "run in". (See section "Safe driving")

Tyre pressures

The tyres must always be inflated to the correct pressures. Low pressures are detrimental to handling and increase fuel consumption.

- The tyre pressures are given under "Technical data" page 89.

The inflation pressures are also given on a sticker on the end of the dash on the driver's side.

- The pressures are for cold tyres. The pressures must not be reduced if tyres are checked when hot and pressure is higher than specified.

Tyre care

- Check tyres occasionally for damage and remove foreign bodies.
- Keep petrol and oil off the tyres.
- Try to avoid exposing the tyres to strong sunlight for weeks on end.
- Replace missing valve caps as soon as possible.

Tubeless tyres

- All factory fitted tyres are tubeless.
- Tubeless tyres must only be fitted to safety (hump) rims.
- Tubes should only be used in tubeless tyres in emergencies. When this is done, ensure that air trapped between tube and tyre can escape at the valve.



Tyre wear

Tyre life depends considerably on the following factors:

- **Inflation pressures**

Pressures which are too high or too low shorten tyre life and also have a detrimental influence on vehicle handling. Low pressure can also cause a tyre to fail suddenly. At high speeds such tyres flex much more and this in turn creates excessive heat. This can cause tread separation and tyre blow-out. The pressures should therefore be checked at regular intervals, preferably when filling the fuel tank, and rectified as necessary.

- **Style of driving**

Fast cornering, violent acceleration and hard braking all increase tyre wear.

- **Season of year and weather**

The tyre treads wear more at high ambient temperatures on dry roads than at lower temperatures on wet roads. The rubber is less resistant to friction when warm than when cold.

- **Wheel alignment errors**

Incorrect adjustment of wheel alignment causes increased, usually one-sided wear and also detracts from vehicles safety.

Wear indicators.

At the bottom of the tread grooves of the original tyres on your vehicle there are a number of 12 mm wide and 1.6 mm high bars running across the tyre.

When these bars appear in two or more adjacent grooves so that there is no longer any tread at these points the tyres concerned should be replaced as soon as possible.

When the tread has worn down to a depth of **1 mm*** measured at any point on the tread, the tyre has reached the limit for safe usage. We advise you however not to let the tyres wear down to this extent as tyres with treads in this condition cannot grip the road surface properly when driving at high speeds on wet roads.

* In other countries this figure may differ.

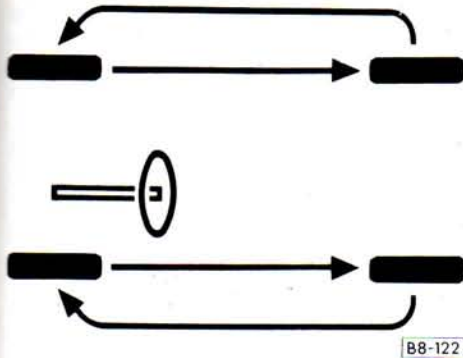

Changing wheels round

In order to avoid having to replace tyres earlier than necessary in case of **uneven tyre wear** it is advisable to change the tyres round as shown below – without altering the direction of rotation.

Replacing tyres

- For safety reasons it is advisable to renew tyres on all four wheels at the same time or to renew them at least in pairs on the axles.
- Vehicles which are fitted in production with radial ply tyres must be fitted with the same type of tyre when replacements are made.
- Only tyres of the same type and tread pattern may be combined.
- A combination of radial ply and normal tyres (cross ply) is not permitted.
- For safety reasons a **new** valve should always be fitted when a new tubeless tyre is being installed.

Wheel balancing

- The front wheels are balanced on new vehicles. As the wheels can get out of balance due to various influences when the vehicle is in use, the front wheels should be balanced again when steering vibration is felt.
- The wheels should also be balanced again when a tyre has been repaired. This also applies to balanced wheels when a tyre has lost all its pressure due to a faulty valve.

Winter tyres see "Winter driving".

Care and maintenance

Car care can be done by every car owner. All that is required is interest and pride in one's own car, a supply of suitable car care materials and a quick glance at our instructions which must be followed exactly.

Maintenance is more than car care. It requires specialist knowledge, workshop appliances and special tools. Even oil changing and lubricating require specialist knowledge and cannot be done properly without the equipment available in a lubricating plant*. This work must be done in accordance with our instructions.

Present day safety regulations and environmental protection place very strict limits on the amount of repairs and adjustments which even a technically skilled and experienced handyman can undertake on the engine and running gear.

* In most countries there are environmental protection laws governing the disposal of old oil.

Tinkering with the vital parts of a motor vehicle can endanger the life and health of all roads users. Alteration of the factory settings of carburetor, ignition or valves invariably changes the emission values and increases fuel consumption and such alterations are forbidden in most countries today.

If you have your vehicle serviced at a V.A.G dealership you can rest assured that everything possible will be done to maintain the road-worthiness, economy and reliability of the vehicle.

The Service Schedule issued with your vehicle tells you in detail what has to be checked and when and what advantages this brings you.

Care of car

Regular and careful care helps to maintain the value of the vehicle. Every V.A.G workshop carries stocks of suitable car care materials. The instructions for use on the container should be followed.

Washing

The best protection against environmental influences is frequent washing and **waxing**. The longer **salt**, road dust, industrial grime, insects and bird droppings etc. are left on the paintwork, the more damage they are liable to do to the finish.

All inside folds, flanges and joints on doors and flaps are particularly **endangered by salt**.

These areas must therefore be carefully cleaned with a sponge and the rinsed and leathered off every time the vehicle is washed – even when it has been through an automatic washing plant.

If the vehicle is washed by hand it should be washed from top to bottom with plenty of clear water and using a sponge or a soft brush. Do not wash car in direct sunshine. Rinse out the sponge thoroughly at frequent intervals in order to avoid scratching the paint.

If clear water does not suffice to remove dirt, add a shampoo to the water. After washing rinse thoroughly with water and dry with a leather. Pay particular attention to folds, flanges and joints on doors and flaps.

Waxing

Wax as often as possible. This will prevent dirt from sticking to the paint and industrial grime from penetrating into the paint. Either apply wax to the vehicle after washing and then polish it or simply add a wash wax solution regularly to the second lot of washing water. Rinse the vehicle with this solution and dry with a leather. Pay particular attention to folds, flanges and joints on doors and flaps.

Polishing

Should only be done if paint has lost its shine and gloss cannot be brought back with wax.

If the polish used does not contain preservative compounds, the paint must be waxed afterwards.

Matt painted surfaces should not be treated with wax or polish because this will spoil the matt finish. This also applies to trim strips of plastic with a matt finish.

Touching up paint damage

Small marks in the paint such as scratches or stone damage should be touched up immediately with paint. (Volkswagen touchup brushes or spray-cans) **before** the metal starts to rust.

However, should rust be found at any time it must be removed thoroughly and then the area treated first with an anti-corrosion primer (brush or spray-can) and then the correct paint applied.

A sticker under the driver's seat on the right side of seat box gives the paint designation and the number of the original vehicle finish.

Removing industrial grime

Treat the paint surface with an industrial grime remover as soon as possible. Do not use in sunlight or on warm surfaces. Do not apply directly to black plastic parts. The solution should be allowed to work for a few minutes and then rinsed off very thoroughly. Pay particular attention to all seams and joints.

Removing tar spots

Treat the paint surface with a tar remover as soon as possible. After treatment rinse away all traces of the tar remover with a detergent solution (water and shampoo).

Removing insects

Dried-on-insects should be removed as soon as possible with insect remover. Wash the paint surface afterwards. Clean dirty windscreens with an insect sponge.

Care of chromed parts

Before applying any chrome cleaner, wash the chrome plated parts thoroughly and dry them. Remove spots and marks with a suitable chrome polish. These materials usually contain a preservative which protects the parts from the weather.

A chrome protective compound can be sprayed to give long-term protection.

Car of plastic parts

Plastic parts and adhesive strips which are exposed to the weather should be cleaned as explained in the section "Washing".

If normal washing is not sufficient, these parts may only be cleaned with special plastic cleaners. The cleaner manufacturers instructions for use should be followed closely. No other cleaning compounds or paint polish should be used because these may attack the plastic parts and strips.

Cleaning and anti-corrosion treatment of engine compartment

The engine compartment and the outside surface of the power unit are given anti-corrosion treatment at the factory. If the engine compartment is cleaned at any time with grease removing solutions or if one has the engine washed, the anti-corrosion compound is nearly always removed as well. It is therefore essential to ask for durable preservation of all surfaces, seams, joints and components in the engine compartment to be carried out.

Good anti-corrosion treatment is very important particularly in the winter. If vehicle is frequently driven on salted roads, the entire engine compartment should be thoroughly cleaned at the end of the salting period at least and then preserved so that the salt cannot have a damaging effect. At the same time the underside of the vehicle should be washed as well.

Your V.A.G dealer has stocks of the high-quality preservation compound recommended by the factory and has the equipment necessary to apply it.

Cleaning and preserving leatherette

Apply plastic cleaner and rub dry with a soft cloth.

Door, flap and window weatherstrips

The weatherstrips will remain flexible and last longer if they are rubbed lightly with a rubber protective compound from time to time. This will also stop the weatherstrips from freezing on in the winter.

Cleaning windows

Windows can normally be cleaned with a sponge and lukewarm water and then dried with a leather.

Do not use the same leather for the paintwork since traces of paint cleaner and polish cause streaks to appear on the windscreen.

Insects can be removed with an insect sponge.

Traces of rubber, oil, grease or silicone can be removed with window cleaner or a silicone remover, depending on how dirty the glass is.

Both solutions can be put into the water in the windscreen washer. In the winter a window cleaner with an anti-freeze agent should be used in the water.

Windscreen wiper blades

Blades which are clogged with insects or oil deposits should be removed and cleaned with a hard brush and a detergent solution. New blades should be installed once or twice a year according to condition.

Airing the interior

If the vehicle is left in a closed garage for a long time, the garage and car doors should be opened occasionally to prevent the formation of mould and damp stains.

Cleaning cloth upholstery

Clean with a vacuum cleaner or a medium hard brush. Spots or very dirty patches can be removed with a suitable cleaner.

Moisten a clean, non-coloured cloth with the cleaner and rub the spot with a circular motion, working inwards.

Cleaning seat belts

Inertia reel belts may not retract properly if very dirty. Dirty belts can be cleaned by washing with a mild soap solution without taking the belts out of the vehicle. Do not have the belts cleaned chemically because the cleaning compounds damage the webbing material. Ensure that the belts do not come into contact with corrosive fluids. Inertia reel belts should be completely dry before they are allowed to roll up. Check occasionally to see that the belt locks and the retractors (inertia reel belts) are working properly. Inspect the belt webbing and the fittings for damage.

Seat belts which have been stressed in an accident and stretched must be replaced and the anchorages should be checked by a workshop.

Cab seats

If the seats become hard to move, clean the runners with a cloth and grease lightly at top and bottom.

Removing seats, see section "Operation", paragraph "Seats".

Cavity preservation

Various cavities in the body are also protected against corrosion and this protection can be intensified by repetition of the preservation.

The best results are obtained when the first subsequent treatment is done about one year after the vehicle is put on the road.

All V.A.G workshops know how and where this treatment has to be carried out and have the factory approved compound and the equipment required.

Undercoating

The underside of the vehicle is coated with a special compound to protect it from chemical and mechanical influences.

However, as this protective layer gets damaged when the vehicle is in use, the undercoating should be examined at certain intervals – preferably before and after the winter season – and any damage made good.

Not all the materials available are suitable for this purpose so we advise you to have patching up or additional coating done by a V.A.G workshop.

Every V.A.G workshop has stocks of the correct compound, has the necessary equipment and is familiar with the application procedure. They know, in particular, what precautions have to be taken in respect of the braking system and the exhaust system to ensure that additional undercoating is applied properly.

Battery

The battery is under the righthand seat. It can be reached when seat is pushed fully forward.

The 2nd battery (optional) is under the lefthand seat.

On vehicles with swivelling seat on the right the seat must be turned 180° and pushed fully forward to get at the battery. See page 12.

On vehicles with swivelling seat on the left and a 2nd battery the seat must be removed to get at the battery. The seat frame must then be turned 180°. See page 12.

As the starting ability of the engine and the functioning of the entire electrical system depend to a great extent on the condition of the battery, it is essential to check and service the battery regularly.

Checking the acid level

The acid level should always be between the two marks on the side of the battery. If it is low, remove the plugs and add distilled water.

Do not fill above the max. mark because the acid will overflow when the battery is being charged and cause damage.

How often the battery has to be checked depends on the operating conditions and the time of year.

If a vehicle is often used for long runs in the daytime when next to no current is being used, the battery will need topping up with distilled water much more often than in the case of a vehicle operating under different conditions. As a general rule the battery acid level should be checked more often in the summer than in the winter.

When driving in hot countries it is advisable to check the battery at least once a week.

If you do not intend to use your vehicle for a long period, the battery should be taken out and, if necessary, charged about every 4 weeks, otherwise it will discharge itself in time and this can cause permanent damage to the plates.

Removing

Loosen terminals. Remove earth strap first then the positive cable. Detach battery securing bracket. Pull battery forward a little and lift it out.

Installing

When installing the battery, first fix the positive cable, then the earth strap. Keep the terminals clean and coat them with terminal grease after fitting the clamps.

Some more points:

- Never **short the battery** terminals as this causes the battery to heat up very quickly and it may burst. Furthermore, the sparks can ignite the gas generated during the charging process. Never use a naked flame near the battery.
- **Battery acid is corrosive** and must not get into the eyes or onto skin and clothing.
- **Never run the engine with the battery disconnected** as this will damage the electronic components in the electrical system.
- To avoid short circuits, disconnect the battery earth strap before starting work on the electrical system. When changing a bulb it is sufficient to switch the lamp off.
- On the other hand, both terminals must be taken off before the battery is given a **quick charge** while in the vehicle.

Starting with a second battery is described in DIY section, page 74.

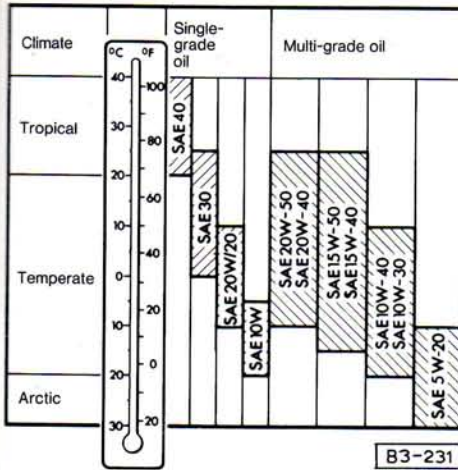

Do not drive with full throttle for long periods when using SAE 10W single-grade oil or SAE 5W-20 multi-grade oil if temperature is above the range shown.

Lubricants

Engine oil

Use only reputable brands of **HD engine oil** marked "SE" according to the API system.

As the operating ranges of neighbouring SAE grade oils overlap, there is no need to change the oil if the temperature varies for short periods.

Gearbox oil and ATF

(all the year in all climatic zones)

Manual gearbox and final drive:

Hypoid oils marked "GL 4" according to the API system or oils which fulfil Mil-L-2105 specifications – SAE 80 or 80 W-90.

Automatic gearbox:

- Converter and gearbox:
ATF Dexron
- Final drive:
Hypoid oils marked "GL 5" according to the API system or oils which fulfil Mil-L-2105 **B** specifications – SAE 90.

Lubricant additives

No additives of any kind should be mixed with the lubricating oils.

Details of oil changing are given on the next pages.

Lubrication

Engine

The engine oil must be changed at least twice each year

Engine oil not only deteriorates when it is in use, the lubricating properties are also impaired by ageing. The oil should, therefore, be changed every 6 months or not later than at the mileages specified in the Service Schedule.

If the vehicle is used in arduous conditions such as very dusty areas, the engine oil should be changed at shorter intervals.

Oil changing in winter conditions is described under "Winter driving".

If you are not sure whether your engine oil should be changed at shorter intervals or not, ask your V.A.G dealer.

Due to the cleansing properties of the HD oils, the fresh oil tends to look dirty after being in use only a short time. This has nothing to do with its lubricating properties and need not worry you.

37 kW engine

- The old oil should only be drained when warm.
- Clean oil strainer at every oil change.

Loosen all six cap nuts but only remove five. Detach strainer plate on one side with a screwdriver and let oil drain out. Remove strainer and clean thoroughly. Use new gaskets and washers when installing.

Oil quantity: With filter change 3.0 litres
without filter change 2.5 litres

51 kW engine

- The old oil should only be drained when warm.
- Remove oil drain plug "A".
- Remove central bolt "B" and take out strainer at the intervals specified in the Service Schedule.

Use new gaskets and washers.

Tighten bolt "B" to 13 Nm (9 lb ft) with a torque wrench.

Oil quantity: with filter change – 3.5 l
without filter change – 3.0 l

See "Lubricants" page 59 for engine oil specifications.

Always check level with dipstick after changing oil: The oil must be near the maximum mark but not above it on any account. See "Checking oil level".

Putting engine oil in – see page 47.

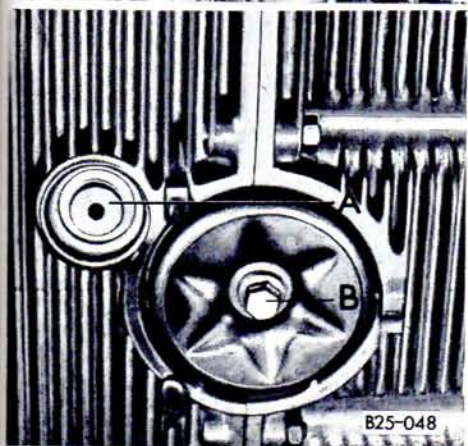
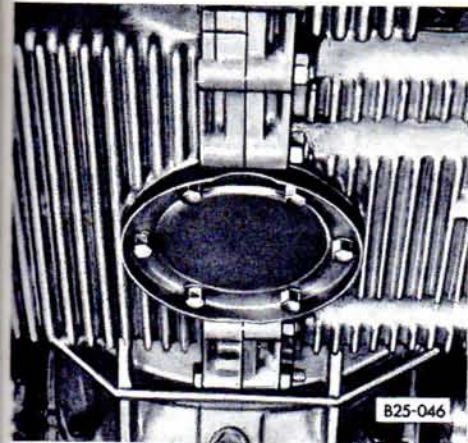

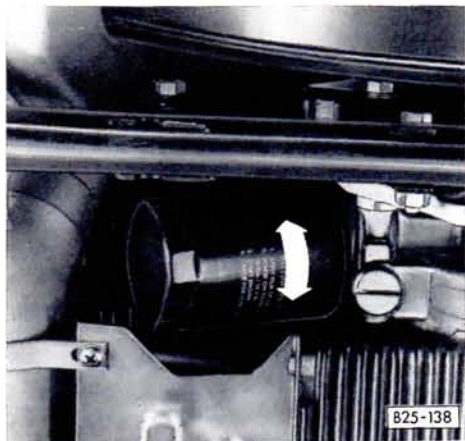

Changing the oil filter

The **filter** is changed at the intervals specified in the Service Schedule.

Loosen and tighten the filter by hand or with the special wrench.

Oil sealing ring on new filter element before installing it.

Only the filter Part No. 070 115 561 is to be used for the 37 kW engine.

37 kW engine



51 kW engine

Additional points to be lubricated

The sliding door link and the rear flap hinges should be oiled at the mileages specified in the Service Schedule or at least once a year, prior to the winter. The double cab door hinges and other flap hinges should be oiled at shorter intervals depending on conditions of use.

Lubricant: SAE 30 engine oil.

Catch surplus oil drops and wipe off carefully.

The battery terminals and posts are coated with **terminal grease**.

The **lock cylinders** in the doors should be lubricated as required with graphite. The key can be dipped in graphite and then turned to and fro in the lock a few times.

Gearbox oil

The gearbox oil is not changed.

Air cleaner

The element should normally be renewed as detailed in the Service Schedule.

In very dusty conditions the element must be cleaned (by beating out carefully with the dirty side downwards) or renewed at shorter intervals.

Cleaner housing must be wiped clean each time. Cover air intake opening so that dirt does not fall into engine.

Ensure that element is installed properly.

Do not clean element in petrol or moisten with oil.

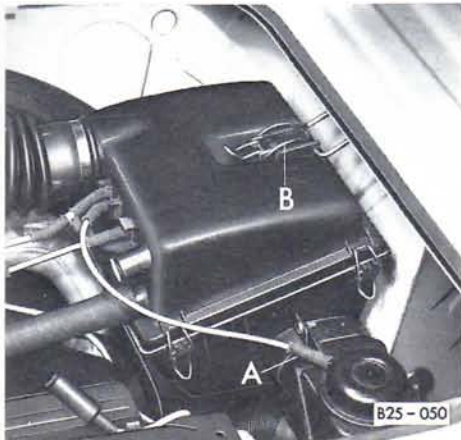

37 kW engine

Cleaning or renewing the element

- Pull vacuum hose A off at cleaner.
- Release clip B.
- Lift cleaner and detach it from the mountings.
- Release 4 clips and take housing apart.
- Take element out and clean or replace.

Insert paper element again carefully and ensure that seal is located properly.

When installing cleaner, insert housing in the rubber grommets on mounting.

Close clip and connect vacuum hose.

Care and maintenance

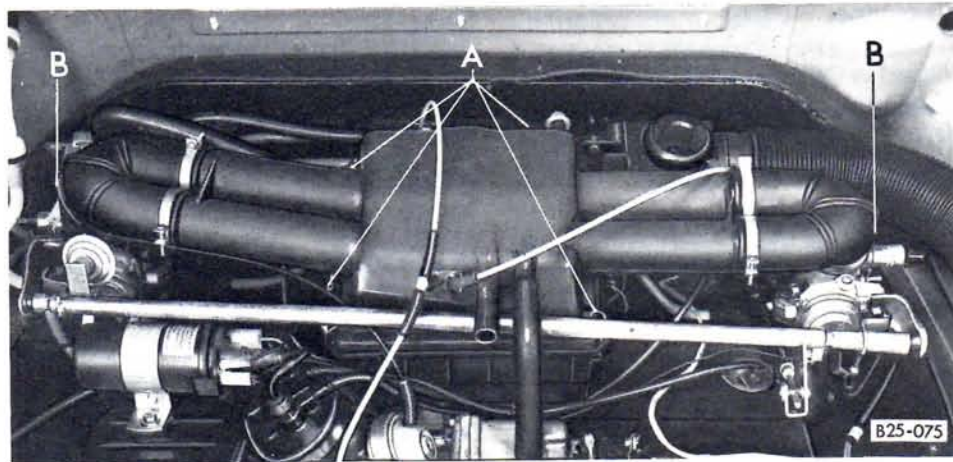

51 kW engine

Cleaning or renewing the element

- Open clips **A**.
- Detach all hose connections on top part of cleaner.
- Remove screws **B** on both carburetors, pull side parts of cleaner off carburetor connections and take cleaner top part off.
- Take element out of bottom part and clean or renew it.

When installing, ensure that the seals are located properly on both carburetors. Connect all hoses again.

In order to ensure satisfactory operation of the temperature and load sensitive intake air preheating it is essential that the two vacuum hoses at front of cleaner are connected correctly.



Lifting vehicle

With a vehicle lift

Before driving over a vehicle lift ensure that there is sufficient clearance between lift and vehicle.

The vehicle may only be lifted at the points shown here.

Front

At the front jacking point (see Fig.)



Rear

At rear cross member (see Fig.)

With a trolley jack

The vehicle should also only be lifted with a trolley jack at the points shown here.

On no account should the vehicle be lifted under the engine gearbox or the front axle as this can cause serious damage.

With vehicle jack

Using the jack is described in the D-I-Y section, under "Wheel changing".

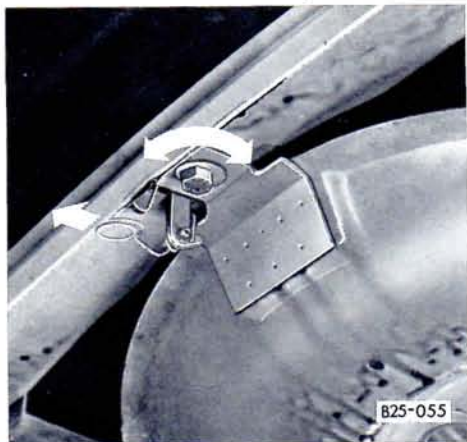

Changing wheels

The spare wheel

is located under the body on a hinged pan. To take wheel out remove bolt with wheel nut spanner.

Caution: Keep clear as the pan falls down. Danger of injury. Then pull wheel forward off the pan.

To stow spare wheel, place it on the pan with offset downwards and swing pan up until hook engages. Then insert bolt and tighten it.

For safety reasons the pan must always be bolted in position so that it cannot release accidentally.



Jack and tools

are under the drivers seat.

Changing a wheel

Preparation

Apply handbrake, engage a gear and scotch a wheel at front and rear on opposite side to that on which wheel is to be removed (use a wedge or stone), to prevent vehicle from rolling away.

Place spare wheel, jack and tools ready for use.

Remove wheel cap by placing hook in holes on edge of cap and levering on edge of rim with wheel spanner.

Loosen all wheel nuts/bolts one turn with wheel spanner.

If you wish to fit non-standard tyres or wheels to your car at any time we advise you to see your V.A.G dealer first because the use of wheels and/or tyres not approved by us may affect the registration of the vehicle under the Construction and Use regulations.



Do-it-yourself

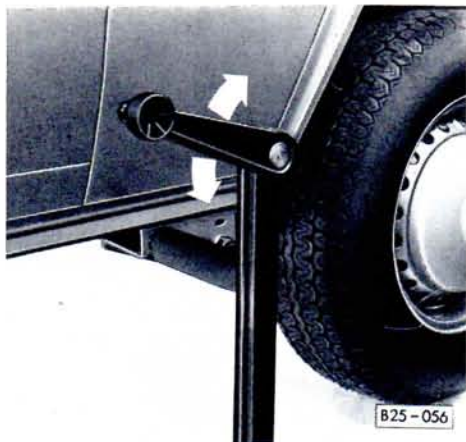

Insert jack arm into jacking point nearest to wheel with flat.

If the ground is so soft that the jack can sink into it, place a large strong support under the baseplate.

Lift the vehicle until the appropriate wheel is off the ground.

Remove wheel nuts/bolts and take wheel off.

Fit new wheel and tighten nuts hand tight with wheel spanner.

Lower vehicle.

Tighten nuts/bolts uniformly and diagonally.

The wheel nuts can be tightened adequately by any normal healthy adult using the tools provided in the proper way. In case of doubt have the tightening torque checked with a torque wrench at the first opportunity.

Tightening torque: 170 Nm (122 ft. lbs).

Install wheel cap.

Stow jack, wheel and tools away again.

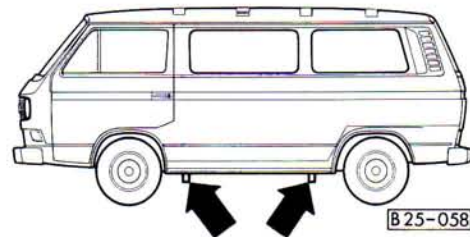
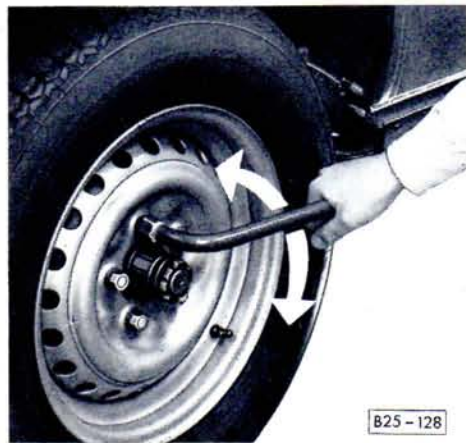

The jack is only designed to lift the vehicle for wheel changing. When working under the vehicle, ensure that it is supported on blocks or trestles.

Check inflation pressure of wheel fitted at the next opportunity and rectify if necessary.

Have the damaged tyre repaired as soon as possible.

Fuses

To prevent damage to the electrical system due to short-circuiting or overloading, each individual current circuit is provided with a fuse.

The fuses are housed in a box with a plastic lid on the left under the dash*.

Changing a fuse

- Switch component concerned off.
- Remove the lid of the fuse box.
- Take defective fuse out of the clips carefully.
- Insert new fuse of same capacity so that the metal strip is visible, but do not grip the metal strip or bend the retaining clips. The fuse must fit tightly between the clips.

Fuse layout

As numbered on the plastic lid:

No.	Component	Ampere
1	Tail light left, parking light left	8
2	Tail light right, parking light right, number plate light, rear fog light	8
3	Low beam left	8
4	Low beam right	8
5	High beam left, high beam warning lamp	8
6	High beam right	8
7	Vacant	8
8	Interior light, socket/cigarette lighter, brake light	8
9	Emergency light system	16
10	Windscreen wiper/washer system, heated rear window	16
11	Turn signals	8
12	Horn, reversing lights	8

Additional fuses in separate holders on right near fuse box.

Fresh air blower	16
Fog lights	16

Fuses for auxiliary heater – see page 34.

Note:

- A blown fuse can be recognized by the break in the metal strip.
- If the newly inserted fuse blows again after a short time, the electrical system must be checked by a V.A.G workshop to find the cause of the short circuit and rectify it.
- On no account should fuses be patched up because this can cause serious damage elsewhere in the electrical system.
- Always carry a few spare fuses on the vehicle.

Relays

Relays for various electrical components are located above the fuse box.

Checking and replacing relays should be done by a V.A.G workshop.

* On RHD vehicles the glove box must first be tipped forward or removed.

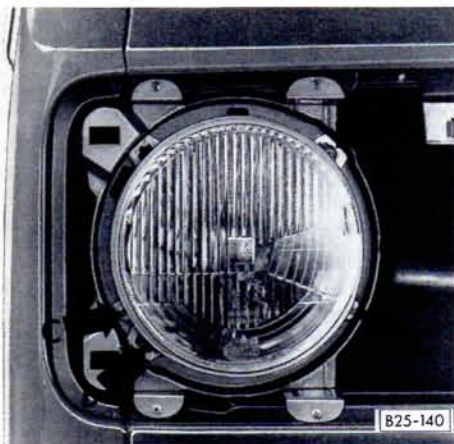

Screw A = Lateral aim
Screw B = Vertical aim
Screws C = Secure headlight

Correct headlight adjustment is very important for vehicle safety. The adjustment should therefore only be done with a special appliance.

Changing bulbs

Before fitting a new bulb, switch off the lamp concerned. Do not touch the glass part of the new bulb with the bare fingers because the finger marks left on the glass evaporate when the bulb gets hot, the vapour settles on the reflector and dims it.

A bulb must only be replaced by a bulb of the same type. The designation is marked on the base of the bulb. It is advisable to always carry a small box of spare bulbs on the vehicle. These can be obtained from any V.A.G Dealer.

Headlight

To change a headlight bulb the headlight must be taken out.:

Remove air intake grille.

Turn 5 quick-release clips 90° with a screwdriver.

Pull grille forward slightly at the top and lift it out.

Remove 3 screws -C- and take headlight out.

Do not turn adjusting screws A and B.

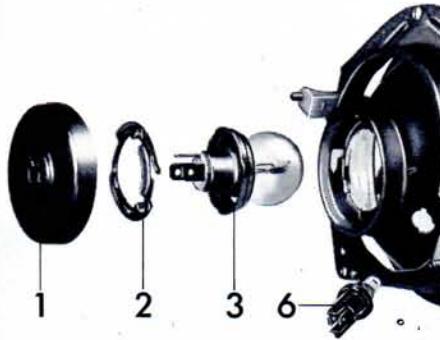

B8-137

Headlights (Normal) A – upper Fig.

The bulb is held in the reflector by a retaining ring.

- Pull connector and cap 1 off headlight.
- Turn ring 2 to the left to take it off.
- Take bulb 3 out of reflector.
- Place new bulb in reflector so that the locating lug on the bulb plate engages the recess at the bottom of the reflector.

The centre terminal of the three on the bulb is then at the top.

- Install ring, press it against reflector and turn it to the right.
- Press cap on carefully so that it contacts the reflector properly and attach connector.
- Have headlight alignment checked.

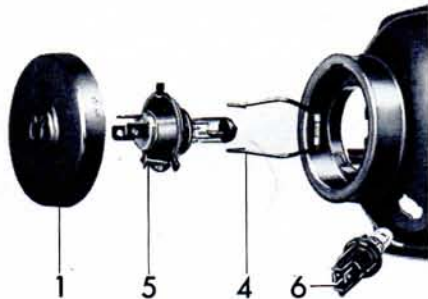

B8-138

Headlights (Halogen H 4) B – lower Fig.

- Pull connector and cap 1 off.
- Squeeze retaining clip 4 together and hinge away.
- Replace bulb 5. Install new bulb so that the centre tab is upwards.
- Hinge clip over bulb base, squeeze it together and engage in retaining lugs.
- Install cap and connector.
- Have headlight alignment checked.

Side light

(Normal and Halogen H4 headlights.)

- Turn bulb holder 6 slightly to the left and pull it out of the reflector.
- Turn bulb to left slightly and take it out.
- Press new bulb into holder and turn it to the right.
- Press holder into reflector and turn to the right.



Rear lights

Remove screws and take out lens and insert. Press the two side lugs together in direction of arrow and take out insert with bulbs.

Press bulb in lightly and turn it to the left to replace it.

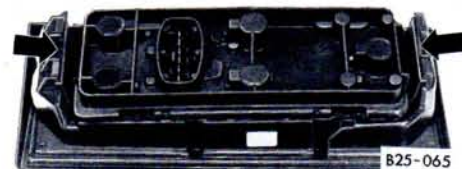

Front turn signals

- Remove screws.
- Take lamp off.
- Pull rubber cap off.
- Press tab inwards and take insert out of housing.
- Turn bulb to the left and renew it.

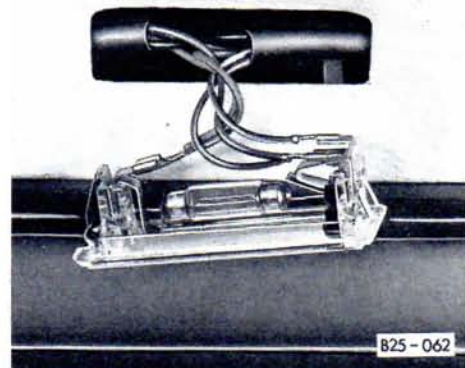

Interior light

The light is held in position by a lug at the switch end and a spring at the opposite end.

- Press spring carefully in towards the light with a screwdriver and lift light out.
- Take bulb out of contacts
- Insert new bulb.
Insert housing at switch end first then press other end in until spring engages.

Number plate light

The number plate lights are pushed into the cross panel from the rear. To replace a bulb, pull complete housing out, take lens off, press bulb into holder, turn it to left and take it out. Insert new bulb and attach lens. When installing housing, ensure that it engages the metal tab at the top and fits in the opening in the cross panel at the front.

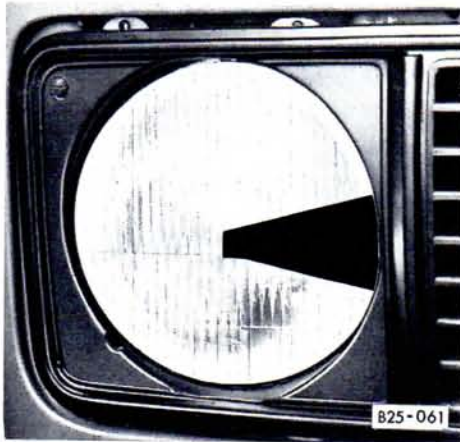

Masking headlights when going abroad

When the vehicle is used in a country which drives on the opposite side of the road to the home country, the asymmetric headlights will dazzle oncoming traffic.

To prevent this, the wedge-shaped sector on the headlight lens must be covered up with an opaque adhesive strip. The illustration shows the strip installed for the change from righthand to lefthand traffic.

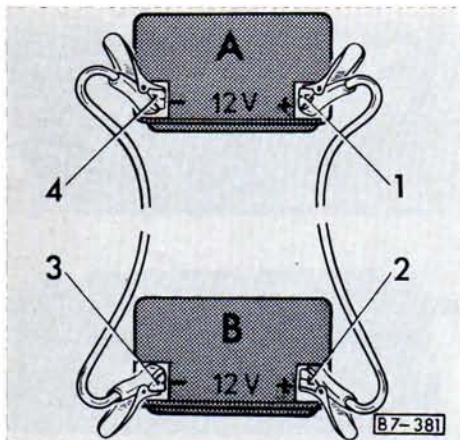

A – Flat battery
B – Boosting battery

The battery is under the righthand seat in the cab.

(see "Battery" page 56).

Emergency starting

If the engine will be not start because the battery has insufficient power in the winter or is flat because the vehicle has not been used for some time, **jumper cables** can be connected to the battery of another vehicle to start the engine. The following points should be noted:

- Both batteries must be 12 Volt types. The capacity (Ah) at the boosting battery must not be a lot lower than that of the flat one.
- The jumper cables must be heavy enough to carry the load. Note cable manufacturer's data.
- A flat battery can freeze at -10°C and if a battery is frozen it must be thawed out before connecting a jumper cable.
- There must be no contact between the vehicles as otherwise current can flow as soon as the plus terminals are connected.
- The flat battery must be properly connected to the electrical system.
- Remove all cell plugs and lay them loosely on the holes.
- The engine of the boosting vehicle must be running.

- Connect jumper cables as follows:
 1. One end of (+) cable (usually red) to the (+) terminal of flat battery.
 2. Other end of red cable to (+) terminal of boosting battery.
 3. One end of (-) cable (usually black) to (-) terminal of boosting battery.
 4. Other end of black cable to (-) terminal of flat battery.

Take great care to ensure that the jumper cable clips do not touch one another and that the plus cable does not touch current conducting vehicle parts – short circuit danger.

- Do not stand with your face over the battery – danger of acid burns.
- Start the engine in the normal way.
- When engine is running, disconnect cables in reverse sequence.
- Screw cell plugs in again.

Towing

So that you can assist other vehicles, and also in case your car ever needs to be towed, towing eyes are provided on the left at the front and the right at the rear. Towropes should only be attached to these eyes.

Avoid excessive towing effort and do not jerk. During towing operations on other than surfaced roads there is always the danger that the attachment point on the body will be overloaded and damaged.

The driver of the towing vehicle must engage the clutch very smoothly when moving off or changing gear. The driver of the vehicle being towed must keep the towrope taut.

The towrope should be slightly elastic to reduce the risk of damage to both vehicles. It is advisable to use only ropes of synthetic materials or with elastic links.

If your vehicle has to be towed at any time note the following points.

- Switch the **ignition on** so that the steering wheel is free and the turn signals, horn, and, if necessary the windscreen wiper and washer can be used.
- As the **brake servo** only works when the engine is running, more pressure is required on the brake pedal when the engine is not running.
- If the vehicle has an **automatic gearbox**, see the instructions in the "Automatic gearbox" section on page 82.

Check whether there are any local traffic regulations concerning the towing of vehicles.

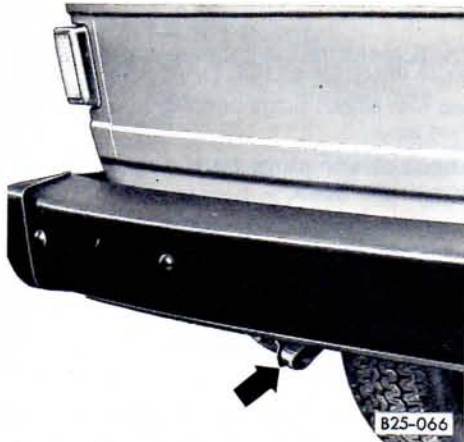



Service installation of belts

Seat belts can be service installed for all seats in vehicles which are not fitted with belts in the factory.

Front

The front anchorages are marked with rings in the illustration. On vehicles with a two-seater bench the anchorages for the centre place are on the inside of the seat boxes.

Rear

Anchorage are provided for all seats in the passenger compartment. Depending on model they are either in the seat frames or the side panels.

The holes for the belt bolts are covered by the interior trim and the holes in the carpet are fitted with plastic plugs or covered with adhesive tape.

These plastic plugs must not be used to attach the belts.

Anchorage which are not being used should be fitted with plugs.

V.A.G. workshops have all the necessary information on the fitting of belts.

The installation of seat belts should therefore preferably be done by a V.A.G workshop.

Hints on fault finding

Some hints on fault finding are given in various parts of this manual. These hints are summarized again here.

Fault	Possible cause	Remedy
Engine is hard to start or will not start at all	Incorrect starting procedure Battery flat (starter not turning)	Use correct procedure (page 21) ● Start with booster battery (page 74) ● Have battery charged (page 58) ● Push or tow start vehicle (not possible with automatic gearbox)
Engine tends to stall when warming up	Carburetor icing	Mix Volkswagen-Audi Petrol Additive with the fuel (page 44)
Oil pressure warning lamp comes on or flickers when engine is running	Oil pressure too low	Stop engine immediately and check oil level. Further notes on page 47
Generator warning lamp comes on when engine is running	V belt slack or broken If belt is in order the generator may be defective	Adjust tension or fit new belt. Without belt, drive slowly (max. 50 km/h) to nearest V.A.G Dealer. Further notes on page 22 Drive to next V.A.G Dealer. Battery with discharge continuously.

Do-it-yourself

Fault	Possible cause	Remedy
Brake pedal travel suddenly increases considerably. Warning lamp comes on while driving.	Failure of a brake circuit	Drive carefully to next V.A.G Dealer Caution! More pedal pressure will be required and stopping distances will be longer (page 50)
Turn signal warning lamp flashes quicker	One signal bulb has failed	Renew bulb (page 72)
Electrical component failed	Fuse blown If lights are involved: Bulb defective	Renew fuse (page 69) Renew bulb (page 70–72)
Vehicle pulls to one side	Tyre pressures differ considerably	Check pressures, inflate if necessary (page 89)

The Automatic Gearbox

consists of an automatic three-speed planetary gearbox and a hydro-dynamic torque converter. In the normal driving range – D – all the forward gears are shifted automatically according to engine load and vehicle speed.

The selector has 6 positions:

- P – Parking lock
- R – Reverse
- N – Neutral
- D
- 2 } Forward ranges
- 1 }

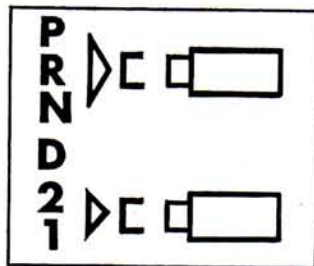

B7-099

A safety catch is provided for selector lever positions P, R and 1.

The catch is released by pressing the button on the side of the selector lever.

When ignition is on the symbol for the selected gear is illuminated in the lever console.

Description

Basic driving rules

- **When moving off, always apply foot-brake or handbrake before selecting a driving range.**

Reason: The torque converter, which also serves as a moving off “clutch”, always transmits a certain amount of power even when the engine is only idling. This means that the vehicle tends to move slowly or “creep” as soon as a driving range is selected. The higher the engine speed is, the stronger is the tendency to creep.

- **When selecting a driving range before moving off, do not depress the accelerator pedal. If the lever has been accidentally moved into “N” from a driving range when vehicle is moving, release accelerator pedal and let engine speed drop to idling before moving lever back into a driving range.**

Reason: When engaged at high engine speeds, the shift clutches in the gearbox are subjected to an excessive amount of strain.

Automatic Gearbox

Selector lever positions

“D” The three forward driving ranges are shifted up and down automatically according to the throttle opening (engine load) and the vehicle speed. “D” is therefore the position for normal driving.

“2” The vehicle moves off in 1st gear and changes into 2nd gear automatically but does not change into 3rd gear. The maximum speed in “2” is 90 km/h (56 mph).

When vehicle is in motion, the lever can be moved from “D” into “2”, with accelerator pedal depressed if necessary. However, as the shift into 2nd gear takes place immediately, this must only be done at speeds **below 85 km/h (63 mph)**.

This is the correct gear for hilly stretches.

“1” The vehicle moves off in 1st gear and remains in this gear. It does not shift into 2nd or 3rd gear.

This is the gear for steep gradients.

This range can also be selected when vehicle is in motion, **but this must not be done at speeds above 45 km/h (28 mph) (Press button on lever)**. If this instruction is not noted, the engine may be damaged by excessive speed.

The maximum speed in 1st gear is 50 km/h (30 mph).

“R” The reverse range must only be selected with the vehicle stationary and the engine idling. Press button on selector lever to engage reverse.

“N” This corresponds to neutral in a normal manual gearbox. Nothing happens in the automatic gearbox.

“P” In “P” the driving wheels are locked = Parking lock. **The parking lock may only be engaged when vehicle is standing still.** To move the lever into or out of “P”, the safety catch must be depressed.

Kick down:

Pressing the accelerator pedal right down past the full throttle operates the kickdown switch. The kickdown switch alters the points at which the automatic gearbox works. There are two variations:

- Maximum acceleration by delaying up-shift until engine is at full throttle (forced throttle).
- Bringing about an immediate downshift at speeds below 90 km/h (56 mph) for fast overtaking and when on hills, that is to say, in those situations where a downshift would appear necessary with a manual gearbox.

If the vehicle is driven with the accelerator pedal fully depressed in this way and with the selector lever at “D”, the gearbox shifts into the next gear at the following speeds:

- from 1 to 2 approx 50 km/h (30 mph)
- from 2 to D approx 90 km/h (56 mph)

Driving tips

Starting

The engine can only be started in "N" or "P". (Other points on starting are as given in section "Operation", paragraph "Starting the engine".)

Moving off

When the lever is moved from "P" to "N" with engine running or into a driving range when moving off, the brakes must be applied at "P" because the reverse gear is engaged briefly (see "Basic driving rules").

Stopping

To stop vehicle temporarily such as at traffic lights, all that is necessary is to apply the brakes. It is not necessary to move the lever to "N" while stationary. The engine should only run at idling speed and the vehicle is held with the brakes.

Parking

In general, applying the handbrake will be sufficient to prevent the vehicle from rolling away. This is of course, assuming that the handbrake is working properly.

However, when additional security is called for, such as when parking on a gradient, the parking lock should be engaged as well.

Basic rules:

- Engage the parking lock **after** applying the handbrake.
- Release the parking lock **before** releasing the handbrake.

When it is freezing, it is advisable to use only the parking lock to secure the vehicle because the brake shoes can freeze on to the drums if the handbrake is applied.

Note:

When a vehicle has been parked on a gradient, using only the parking lock, it may be found that a fair amount of force is required on the lever to release the parking lock. This is caused by the load on the parking lock mechanism and is quite normal.

Automatic Gearbox

Driving in mountains

On hilly stretches and particularly in mountainous areas the driver of a vehicle with automatic gearbox should be prepared to use the selector lever.

On steep roads with lots of sharp corners it is, however, advisable to select driving range "2". This prevents the gearbox from shifting up and down unnecessarily. On downhill stretches the selection of a lower range is even more important: Safety can be improved and the strain on the brakes relieved by the increased engine braking available in 2nd gear.

On very steep downgrades, select range "1" in good time so that the maximum engine braking force is available.

Emergency starting

On vehicles with an automatic gearbox the engine **cannot** be started by towing or pushing the vehicle.

If the engine will not start because the battery is flat, it is possible to start it by connecting jumper cables to the battery of another vehicle.

See further detail under "Emergency starting in D-I-Y" section.

Towing

- Selector lever at "N"
- **Do not tow faster than 30 mph (50 km/h).**
- **Do not tow further than 30 miles (50 kilometers).**
- If the vehicle has to be towed long distances it must be lifted at the rear or the drive shafts must be removed.

Reason: When the engine is not running, the gearbox oil pump is not working and the gearbox is not adequately lubricated for high speeds or long distances.

Trailer towing

When towing a trailer in flat country, it is only necessary to note what has already been said about driving a vehicle with automatic gearbox. The general instructions under "Trailer towing" also apply in this case.

In the interests of safety, however, and taking into account the additional load placed on the automatic gearbox and the brakes when driving in hilly districts, the following points should be given special attention:

- On steep hills and in traffic situations where it is obvious that only low speeds are possible, it is better to select driving range "2". In range "2" the driver can control the vehicle and trailer better.
- For long downhill stretches it is essential to select range "1" in order to get maximum benefit from engine braking and relieve strain on the brakes. If the gradient is only slight, sufficient braking effort may possibly be obtained in range "2".

Lubrication

The torque converter and the automatic gearbox are both lubricated by a common supply of ATF.

The final drive housing is filled with hypoid gearbox oil.

See "Care and maintenance" section, para. "Lubricants" for specifications.

Checking ATF level

The correct ATF level is essential to the service life and operation of the gearbox. The level should therefore be checked at frequent intervals, for instance, when the engine oil has been checked.

In the engine compartment is a dipstick which is attached to the filler tube cap.

Note the following points when checking:

- The ATF must be lukewarm. Do not check level when oil is hot or cold.
- The vehicle must be on a level surface.
- The selector lever must be at "N" and the handbrake applied.
- During the check the engine must be running at idling speed.
- Use only clean lint-free rag to wipe the dipstick.

The level must be between the two marks on the dipstick.

If level is too high or too low do not just add or drain oil. Consult a V.A.G Dealer as soon as possible so that the cause of the deviating level can be ascertained.

Changing the ATF

The ATF is changed regularly at long intervals as detailed in the Service Schedule. This requires specialist knowledge and should preferably be done by a V.A.G Dealer.

Please note that in arduous operating conditions (trailer towing, stop/go and city traffic, continuous mountain driving, high ambient temperatures) the ATF is changed more frequently.

Details of these intervals are also given in the Service Schedule.

When there is no ATF in the converter and gearbox, the engine must not be started nor should the vehicle be towed.

The oil in the final drive does not need changing.

Technical Description

Body

Integral body/chassis design ● Floor plates reinforced by side and cross members.

Front axle

Independent suspension with wishbones/track control arms, coil springs, telescopic dampers ● Anti-roll bar

Steering

Rack and pinion steering with relay idler ● Safety steering column.

Rear axle

Independent suspension with diagonal trailing links, coil springs and telescopic dampers ● Double jointed drive shafts.

Brakes

Hydraulic dual circuit system ● Discs at front ● Self-adjusting drums with retardation-sensitive pressure regulator at rear ● Brake servo (51 kW engine) ● Handbrake effective on rear wheels.

Power transmission

Single plate dry clutch ● Baulk synchronized four-speed gearbox and differential in one housing or hydro-dynamic torque converter and 3-speed automatic gearbox (51 kW engine), flange fitted final drive ● Rear wheel drive.

Engine

Located at rear, rear wheel drive

	37 kW	51 kW
Type	4 cylinder, 4 stroke, horizontally opposed	
Cylinders	Cast iron	
Cylinder heads	Light alloy	
Crankcase	Light alloy	
Crankshaft	4 bearings	
Valve gear	via push rod and rocker arms, hydraulic tappets	
Engine cooling	Air with fan	
Lubrication	Pressure feed system with gear type pump, oil filter and cooler	
Fuel system	1 down draft carburetor with automatic choke and accelerator pump	2 down draft carburetors with automatic choke and accelerator pump
Air cleaner	Dry type with paper element	

Technical Data

Numerous European countries are starting to use the new international units for technical measurements. Examples of these units are as follows:

	Old unit	New unit	Remarks
Output	bhp	kW (Kilowatt)	1 bhp = 0.736 kW; 1 kW = 1.36 bhp
Torque	lb ft	Nm (Newtonmeter)	1 lb ft = 1.36 Nm
Revolutions	rpm	1/min ¹)	new way of writing
Pressures	psi	bar pressure	1 psi = 0.07 kg/cm ² = 0.07 bar

¹) For example 2700/min

Engine data	37 kW engine	51 kW engine
Bore (mm)	85.5	94
Stroke (mm)	69	71
Capacity (cm ³)	1584	1970
Compression ratio	7.4	7.4
Maximum output in kW (bhp) DIN 70 020	37 (50) at 4000 rpm	51 (70) at 4200 rpm
Maximum torque in Nm (lb ft) DIN	103 (74) at 2400 rpm	137 (99) at 3000 rpm
Fuel rating (RON)*	91	91
Oil consumption in litre/1000 km	1.4	1.4

Technical Data

Performance

	37 kW engine manual gearbox	51 kW engine manual gearbox	51 kW engine automatic gearbox
Maximum and cruising speed* in km/h:			
Manual gearbox:			
Bus, Combi	110 km/h	127 km/h	122 km/h
Pick-up, double cab pick-up without cover	117 km/h	123 km/h	120 km/h
High-roofed delivery van, high-roofed combi	105 km/h	115 km/h	117 km/h
Pick-up, double cab pick-up with cover	105 km/h	115 km/h	115 km/h
Pick-up with large platform	105 km/h	122 km/h	113 km/h
Hill climbing ability with full load on good roads driving non-stop in 1st gear	26 %	29 %	33 %

Electrical system

	37 kW engine	Part No.	51 kW engine	Part No.
Voltage (V)	12		12	
Battery (Ah)	45/54*/63*		45/54*/63*	
Starter (kW/hp)	0.8 (1.1)		0.8 (1.1)	
Alternator with voltage regulator (W)	630/910*		630/910*	
V belt (mm)	9.5 x 1165	070.903.137	9.5 x 1165	070.903.137
Belt tension:				
Deflection (mm)** new	9-11		9-11	
Deflection (mm)** used	11-14		11-14	
Spark plugs	Bosch W7A (W175T1) Beru 14-7A (175/14)	N 17 801.1 N 17 802.1	Bosch W8C (W145T2) Beru 14-8C (145/14/3) Champion N7 For heavy duty operation at above 25° C Bosch W7C (W175T2) Beru 14-7C (175/14/3)	N 17 811.26 N 17 812.24 N 17 813.14
Plug thread (mm)	14		14	
Electrode gap (mm)	0.6-0.7		0.6-0.7	

Capacities

	37 kW engine	51 kW engine
Fuel tank	about 60 l (13 galls) (10 of which are reserve)	about 60 l (13 galls) (10 of which are reserve)
Engine oil	3.0 l (5.2 pints) with oil filter change* (4.3 pints) 2.5 l (4.4 pints) without filter change*	3.5 l (6.1 pints) with oil filter change* 3.0 l (5.2 pints) without filter change*
Windscreen washer With headlight washer	about 3.5 l (6.125 pints) about 6.5 l (11.2 pints)	about 3.5 l about 6.5 l

* HD oil. Further details are given in "Lubricants" section.

Wheels

	37 kW engine	51 kW engine
Wheels	Perforated steel disc wheels with hump drop centre 5 1/2 J x 14	
Tyres Standard Optional	7.00 14 8 PR 93 P 185 SR 14 Reinforced or 185 R 14 C 6 PR	185 SR 14 Reinforced 185 R 14 C 6 PR

If you wish to fit non-standard tyres or wheels to your car at any time we advise you to see your VW-AUDI Dealer first because the use of wheels and/or tyres not approved by the factory may affect the registration of the vehicle under the Construction and Use regulations.

Tyre pressures* (bar/psi)	front	rear
7.00 14 8 PR	2.3 (33)	3.3 (47)
185 R 14 C	2.6 (37)	3.8 (54)
185 SR 14 Reinforced	2.3 (33)	2.9 (41)
Ambulance with 185 SR 14 Reinforced	2.3 (33)	2.6 (37)

* The pressures are also given on a sticker on the left door pillar between the hinges.

Technical Data

Weights (kg)

Vehicles with 37 kW engine

	Bus	Van	High roofed Van	Combi with seats	High roofed Combi with seats	Pick-up	Pick-up with large platform	Double cab Pick-up	Ambulance
Total permissible weight	2310	2360	2360	2360	2360	2360	2360	2360	2300
Permissible front axle load	1100	1100	1100	1100	1100	1100	1100	1100	1100
Permissible rear axle load	1300	1300	1300	1300	1300	1300	1300	1300	1200
Unladen weight (with driver)**	1410**	1365	1415	1365**	1415**	1365	1460	1450	1650
Payload	900	995	945	995	945	995	900	910	650
Roof load*	100	100	—	100	—	—	—	75	100

Vehicles with 51 kW engine

Total permissible weight	2310	2360	2360	2360	2360	2360	2360	2360	2300
Permissible front axle load	1100	1100	1100	1100	1100	1100	1100	1100	1100
Permissible rear axle load	1300	1300	1300	1300	1300	1300	1300	1300	1200
Unladen weight (with driver)**	1440**	1395	1445	1395**	1445**	1395	1490	1480	1680
Payload	870	965	915	965	915	965	870	880	620
Roof load*	100	100	—	100	—	—	—	75	100

* Only use racks supported in rain channel. Load evenly. Total weight must not be exceeded.

** Without driver

90 *** The addition of optional extras and accessories could alter the unladen weight, resulting in an appropriate reduction in the payload permitted.

Weights

Vehicles with automatic gearbox

	Bus	Van	High roofed Van	Combi with seats	High roofed Combi with seats	Pick-up	Pick-up with large platform	Double cab Pick-up	Ambulance
Total permissible weight	2310	2360	2360	2360	2360	2360	2360	2360	2300
Permissible front axle load	1100	1100	1100	1100	1100	1100	1100	1100	1100
Permissible rear axle load	1300	1300	1300	1300	1300	1300	1300	1300	1200
Unladen weight (with driver)***	1480**	1435	1485	1435**	1485**	1435	1530	1520	1720
Payload	830	925	875	925	875	925	830	840	580
Roof load*	100	100	—	100	—	—	—	75	100

* Use only racks supported in rain channel. Load evenly. Total weight must not be exceeded.

** Without driver

*** The addition of optional extras and accessories could alter the unladen weight, resulting in an appropriate reduction in the payload permitted.

Trailer weights (kg)

	37 kW engine Manual gearbox	51 kW engine Manual gearbox	51 kW engine Automatic gearbox
Permissible weights*			
Trailer with brakes, gradients up to 12 %	1000	1200	800
Trailer without brakes	600	600	600
Permissible nose weight max.	50**	50**	50**

**These figures are valid in
West Germany only. In other
countries they may vary.**

* See "Trailer towing" pages 42/43.

** Minimum nose weight at least 4 % of actual trailer weight but need not be more than 25 kg.

Technical Data

Dimensions (mm)

	Bus	Van	High roofed Van	Combi with seats	High roofed Combi with seats	Pick-up	Pick-up with large platform	Double cab Pick-up	Ambulance
Length*	4570	4570	4570	4570	4570	4570	4570	4570	4570
Width	1845	1845	1845	1845	1845	1870	2000	1870	1845
Height	1950	1965	2365	1960	2360	1930	1930	1925	1940
with cover	—	—	—	—	—	2235	2235	2230	—
Ground clearance at max. weight	190	190	190	190	190	190	190	190	190
Overhang									
front	1160	1160	1160	1160	1160	1160	1160	1160	1160
rear	950	950	950	950	950	950	950	950	950
Wheelbase	2460	2460	2460	2460	2460	2460	2460	2460	2460
Track	1570	1570	1570	1570	1570	1570	1570	1570	1570
Turning circle (m)	10.7	10.7	10.7	10.7	10.7	10.7	10.7	10.7	10.7

Identification Plate, Chassis Number, Engine Number

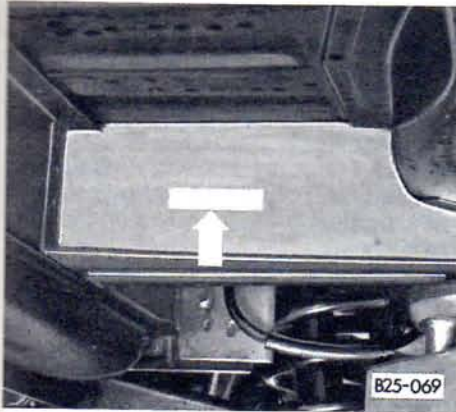

Chassis number

Under vehicle on front cross member

Engine number

The engine number on both engines is on the righthand side directly in front of the fan.

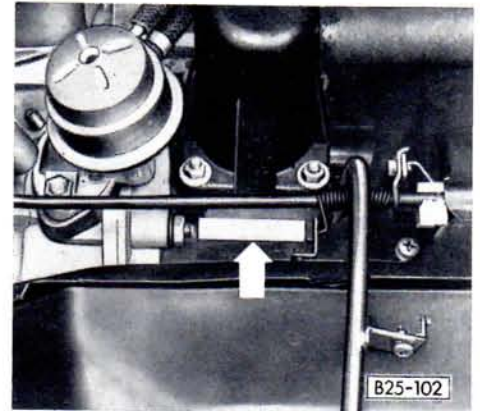

Engine number 37 kW engine.

Chassis number



Identification plate*

On righthand door pillar between the hinges.

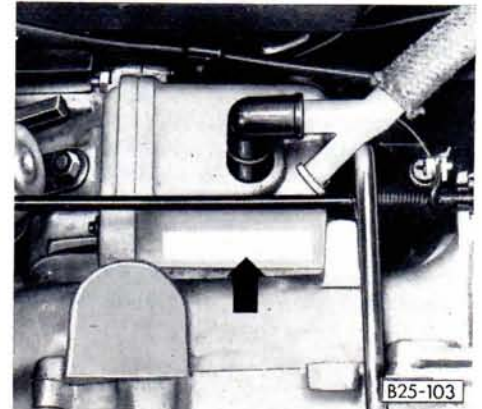

Engine number 51 kW engine.

Identification plate

* Vehicles for export to certain countries have no identification plate.

Alphabetical Index

Additional fuses	69	Care and maintenance	54	Electrical system	88
Additional lubricants	59	Care of car	55-57	Emergency light system	27
Additional points to be lubricated	62	Care of chrome	56	Emergency starting	74
Adjusting jets	49	Care of weatherstrips	56	Engine	85
Air cleaner	63, 64	Cavity preservation	57	-data	86
Ashtray	35	Changing bulbs	70	-number	93
ATF	59, 83	Changing wheels	66	-oil	59
Automatic gearbox	79	Chassis number	93	-oil filter	62
Auxiliary heater	34	Cigarette lighter/socket	35	-oil capacity	47, 61
		Cleaning and preserving		-oil changing	61
		engine compartment	56	-oil consumption	39, 86
		cleaning cloth upholstery	57	-oil level	47
		cleaning leatherette	56	-oil pressure	22
		Clock	25	-oil strainer cleaning	61
		Contents	45	-starting	21
				Engine compartment cover	46
Backrest adjusting	12	Defrosting windows	30		
Balanced wheels	53	Difficult starting	77	Fault finding	77, 78
Battery	41, 58	Dimensions	92	Filling tank	45
Blower switch	30	Dip switch	28	Fog lights	27
Brake fluid	50	Do-it-yourself	66-78	Foot brake	23, 84
Brake fluid reservoir	50	Doors	8, 9	Front seat	12
Brake linings	38	Door windows	8, 9	Frozen windows	41
Brake servo	50	Driving economically	39	Fuel	
Brake system	23, 38, 50, 84	Driving in winter	40	-additives	44
Brake warning light	23	Driving lights	26	-consumption	87
Braking distance	23, 28	Driving safety	38	-filling tank	45
Bulb changing	70	Driving tips	37-43	-gauge	25
Cab doors	8				
Canopy	36				
Capacities	89				

Alphabetical Index

- tank capacity	45, 89	Increasing size of luggage area	18	Lubrication	60
- type	44	Industrial grime	55	Luggage compartment	18
Fuses	69	Insects	56		
		Instrument lighting	26		
		Instrument panel	6		
		Instrument panel lighting	26		
Gear lever	19	Instruments	24, 25	Maintenance flap	47
Gearshift marks	24	Intake air preheating	40	Mirror	36
Gear oil	41, 62	Interior light	36, 72		
Generator	22, 88	Interior mirror	36		
Generator warning lamp	22				
Glove box	35				
		Jack	66, 68	Number plate lighting	73
		Jacking points	55-57		
		Jets adjusting	49		
Handbrake	20, 41			Octane number	44
Headlights				- oil pressure	22
- adjusting	70			oil pressure warning lamp	22
- masking when going abroad	73			oils	59
- washer	29	Keys	8	oil filter	62
Headlight flasher	28	Kick-down	80	oil capacities	47-61
Head restraints	14			oil dipstick	47
Heated rear window	27			oil consumption	39, 86
Heating	30			oil changing	61
High beam	22, 28	Lap belts	16	oil additives	59
Horn	7	Lifting vehicle	65, 68	Operating instructions	44-53
		Lighting	26	Operation	8-36
		Lighting switch	26, 70-73	Out of balance wheels	53
		Loading limit	36	Outside mirror	36
Identification plate	93	Lubricants	59		

Waxing	56
Weights	90,91
Wheels	
–balancing	53
–changing	66
–technical data	89
Windows	
–cleaning	56
–defrosting	30
Windscreen washer container	48
Windscreen washer system	29
Windscreen wiper blades	56
Windscreen wipers	29
Winter operation	40,41
Winter tyres	40

Volkswagen Transporter englisch

1. 80